



User's Manual

Network PTZ Camera



CONTENT

Chapter 1 Precautions.....	3
Chapter 2 Structure.....	5
Chapter 3 Functions Description.....	6
3.1 Features.....	6
3.2 Function Instruction.....	8
3.3 Specification.....	8
Chapter 4 Installation Guide.....	8
4.1 Preparation.....	15
4.2 Installation.....	15
4.3 Interface Instruction.....	18
4.4 Installation Procedures (Take Wall Mount as Example).....	19
4.5 External Cable Connection Instruction.....	21
Chapter 5 WEB Instruction.....	21
5.1 System Requirement.....	21
5.2 Built-in Web Instruction.....	21
5.3 Log in.....	22
5.4 Preview.....	22
5.5 Playback.....	26
Chapter 6 Configuration.....	30
6.1 Audio Video Set.....	30
6.2 Dome Set.....	33
6.3 VCA.....	41
6.4 OSD.....	50
6.5 Storage Management.....	51
6.6 Network Management.....	53
6.7 User management.....	55
6.8 Alarm Management.....	56
6.9 PTZ Management and Control.....	58
6.10 Advance.....	58
Chapter 7 Simple Problem-solving Methods.....	60
Chapter 8 After-sales Service.....	62
Appendix I Lightning and Surge.....	63
Appendix II::Hoisting construction Guide.....	65

Chapter 1 Precautions

In order to avoid danger and operate the products correctly, please read this manual carefully before installation.

The precaution contains two parts “Warning” and “Note” as following:

	
<p>Warnings alert the user to avoid the potential risk of death or serious injury</p>	<p>Cautions alert the user to avoid the potential risk of injury or property damage</p>



Warning:

- Please use AC 24V power supply meeting SELV(Safety Extra Low Voltage) and in accordance with IEC60950-1 compliance with Limited Power Source
- Please contact nearest distributor or service center if the products don't work properly, do not remove or modify the device in any way (unauthorized modification or repair problems caused by your own risk).
- Please don't expose the indoor product to rain or moisture.
- The installation should be performed by professional staff, and comply with local regulations.
- Please mount easily using power protection device in the wire installation.
- Please make sure the connection can withstand at least 50 Newtons vertically downward pull.



Note:

- Please check if the power supply is correct.
- In transportation and storage process, please prevent stress, severe vibration and immersion to avoid any damage
- Please don't touch the image sensor and housing directly, if necessary, please gently clean with alcohol dampened.
- Please don't touch the cooling components directly, in order to avoid burns.
- Please don't focus aligned glare (such as lighting, sunlight, etc.), otherwise it will easily lead to too bright or pull light phenomena, also affect the image sensor life.
- The laser beam may burn the image sensor, so when it is used, please don't expose the image sensor in laser beam.
- Please don't put it in the damp, dusty, extreme heat, extreme cold, strong electromagnetic radiation places.
- Please make sure the installation location keep enough distance from the electromagnetic



sensitive devices surrounding to avoid electromagnetic interference.

- Please prevent heat buildup and keeping the surrounding ventilation.
- Please prevent the speed dome from water or any liquid.
- The product must be carried by original package, either in delivery to users or in return delivery to the factory for repairing. Otherwise, damage caused in transportation will not be covered by warranty.
- The battery replaced incorrectly will lead to use of exceptions, and we don't recommend users to replace directly; If necessary, please use batteries recommended by the manufacturer (for devices with battery).
- Please don't dismantle internal parts, please turn to qualified maintenance professionals to carry out repairs
- Long-term high speed cruising may cause slip rings broken and belt aging, also affect speed dome life.

The wiper will stop working under Zero degree automatically, prevent equipment damage and prolong the service life, there is no rain, please do not use wiper to avoid damaging.

The running speed of the PTZ will be automatically adjusted according to the external environment, the super low temperature environment (-20 degrees below) the PTZ running speed will be slightly decreased.

• **Working Environment**

	Speed Dome
Environmental temperature	-40°C ~ +65°C
Moisture	<95% (Non-condensing)
Atmospheric pressure	86 ~ 106KPa
Power	AC24V/2.0A

Note: make sure outdoor installation meets water-proof requirements.

Assembly environment description:

In order to avoid the fog in the PTZ cover, please assemble the cover in the ventilation and dry conditions, and to ensure that PTZ screw tightening.

Different models of PTZ function is slightly different, specific functions, please refer to the actual functional interface.

Chapter 2 Structure

Front view

Side view

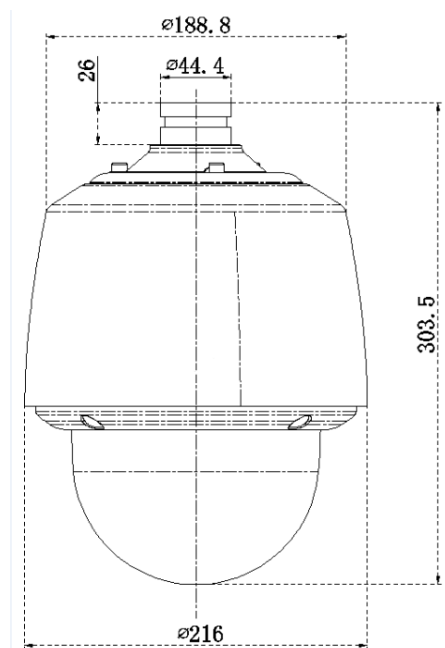
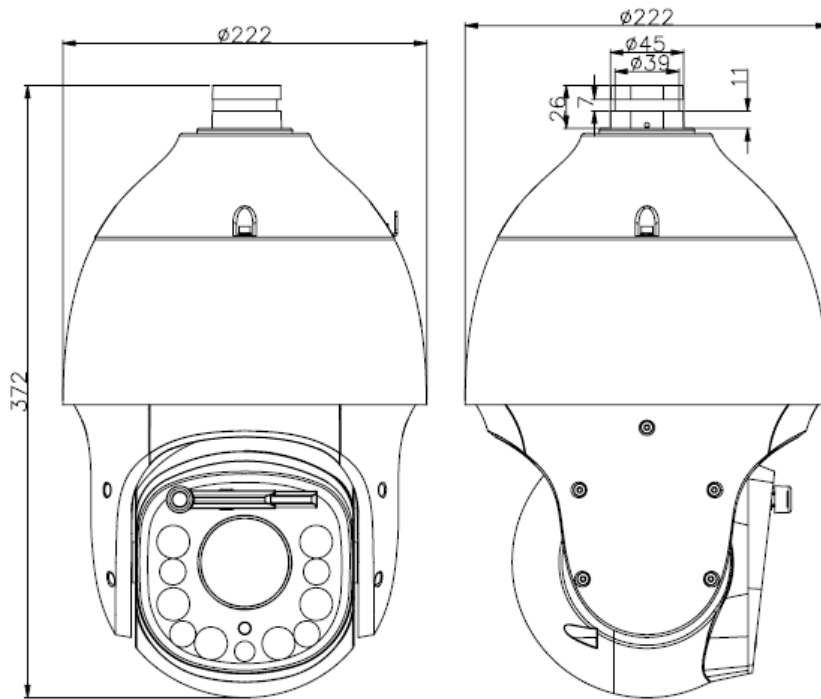

Chapter 3 Functions Description

3.1 Features

1. Built-in Decoder

- HD IP Speed Dome, support 720P 25/30fps or 1080P 25/30fps output. 3MP HD PTZ support QXGA 25/30 fps output.
- Support English menu
- Support standard Onvif
- Power-off protection, no data loss
- RJ-45 port network port
- Support PELCO_P,PELCO_D protocols.
- Support 3D location
- Support standby function
- 470 programmable presets
- 8 cruising tracks, each cruising track has 32 preset positions
- 8 auto scan tracks, the left and right boundaries and scan speed can be set
- Support OSD, date and time display
- Support 1 channel alarm input and 1 channel alarm output(Auto-tracking PTZ support 8 channel alarm input and 2 channel alarm output, standard PTZ support 1 channel alarm input and 1 channel alarm output)
- Support TF storage and local capture

2. Integrated Universal Speed Change Rotator

- Manual Speed:0.05°~160°/s, Max speed 240°/s
- 360° continuous pan rotation, high speed dome camera -15~90, IR high speed dome camera -16~90
- Stepless speed change, auto zoom/speed matching
- Classic double bearing structure, more stable operation
- Delicate stepping motor, stable, sensitive and accurate

3. All-weather Outdoor Design



- Sensor intelligent control
- Double housing structure
- IP66 water proof
- Support anti- lightning and anti-surge

4. Camera Module

- Support auto iris, auto focus and auto BLC
- Mini. Illumination 0.5Lux/F1.6(color),0.095Lux/F1.6(B/W) Starlight series PTZ:
0.002Lux/F1.5(color),0.0002Lux/F1.5(B/W)
- Support 3D noise reduction and WDR

5. Network

- Support Ethernet control
- Support remote view and control by browser and client software
- Support Micro SD card
- Support NFS
- Support remote view and control by browser and client software
- Support Micro SD card
- Support for NFS record
- Support four levels user authority
- Support for authorized users and passwords, support HTTPS encryption and IEEE 802.1x network access control
- Support dual-stream, Triple-stream support H.264/MJPEG/H.265, support multi-level video quality configuration, and support real-time video output resolution 1080p, 960p and 720p
- Support multiple network protocols, IPv4/IPv6, HTTP, HTTPS, 802.1x, Qos, FTP, SMTP, UPnP, SNMP, DNS, DDNS, NTP, RTSP, RTP, TCP / IP, DHCP, PPPoE

6. IR Function

- Mini. Illumination 0Lux
- Adopt array IR, low consumption, IR distance 150m
- IR LEDs and zoom auto match
- Support NFS

- Built-in heat treatment and defog systems
- Constant current circuit design, IR LED life >30,000 hours

3.2 Function Instruction

- **Focus/Rotate Auto Match**

Speed Dome can auto adjust pan and tilt rotation speed depending on the focus distance.

- **Preset Position Setting and Calling**

Preset function means the speed dome can memory current pan/tilt angel, focus, zoom, ect. When need, it can be called upon directly. Our speed dome support up to 255 preset positions.

- **Auto Scan**

Users can set the left and right boundaries by control keyboard. Then speed dome can scan between it. It can set up to 8 groups scan path.

- **Auto Cruising**

Users can program some preset positions into auto cruising sequence, then the speed dome can track as it. Each cruising tracks has 32 preset positions.

- **Pattern Tour**

Speed Dome can memory 180s running path. When start pattern tour, speed dome can track as recording path. It supports 4 groups pattern tour.

- **Guard Location**

The dome will rotate back to preset position after a period of vacant time.

- **Power-off Protection**

Speed dome can resume operation status before the power-off, no data loss.

3.3 Specification

Specification		Model		
		HD IP IR Speed Dome		
Camera	Sensor	1.3M:IMX225-1/3" CMOS	2M:MN34229-1/3" CMOS	3M:IMX123-1/2.8" CMOS
	Pixel	1.3M	2.1M	3.2M

	Image Resolution	Color:0.5 Lux @ (F1.6,50 IRE,ICR close) B/W:0.095 Lux @ (F1.6,50 IRE,ICR open)		
	Resolution	≥720TVL	≥1000TVL	≥1400TVL
	White Balance	Auto / Semi-auto/Sunshine/Daylight Lamp/Warmlight Lamp/Filament Lamp/Nature Light/Lock White Balance/Manual		
	GC	Auto /Manual		
	S/N	>50dB		
	Noise Reduction	3D&2D		
	WDR	Support		
	Electronic Shutter	1/1 ---1/100000s		
	Day/Night	Auto ICR		
	Focus	Auto / Manual/ Semi-auto		
Lens	Focal Length	5.4~97mm,20X	5.2~98mm,20X	4.6~152mm,33X
	Zoom	3S	5S	5S
	Horizontal Angle	50.2°-2.9°	55.8°-3.2°	60.8°-2.08°
	Near Distance	10~50mm	100~150mm	100~150mm
	Iris	F1.6 ~F2.7	F1.5 ~F3.0	F1.6 ~F4.8
PTZ	Horizontal Rotation Range	360°continuous rotation		
	Horizontal Speed	0.1°~160°/s (stepless speed)		
	Vertical Rotation Range	-16°~90°auto flip		
	Vertical Speed	0.05°-120°/s		
	Preset	500		
	Auto Cruise	16 group, each group can set 32 preset		

	Auto Scan	Support track, horizontal, vertical, frame, whole view and random scan		
	Guard Location	Link preset/scan/cruise/pattern		
	Power off Memory	Support		
	Position Information Display	On/Off		
IR	IR Distance	150m		
	IR Angle	Zoom matching, far/middle/near		
Network	Image resolution	1280×960	1920×1080	2048×1536
	Frame rate	50Hz: 25 fps (1280×960) 25 fps (1280×720) 60Hz: 30 fps (1280×960) 30 fps (1280×720)	50Hz:25fps(1920×1080) 80) 25fps(1280×960) 25fps(1280×720) 60Hz:30fps(1920×1080) 80) 30fps(1280×960) 30fps(1280×720)	50Hz:25fps(2048×1536) 36) 25fps(1920×1080) 25fps(1280×960) 25fps(1280×720) 60Hz:30fps (2048×1536) 30fps (1920×1080) 30fps(1280×960) 30fps(1280×720)
	Video Compression	H.264/MJPEG/H.265		
	Audio Compression	G711A/G711U/G726/ADPCM/AAC		
	Network Protocol	IPv4,HTTP,HTTPS,802.1x, FTP,SMTP,UPnP,SNMP DNS,DDNS,NTP,RTSP,RTP,TCP/IP,DHCP,PPPoE		
	Preview Channel	Max 20ch		
	Stream	Triple		
	Authority	32 users, 4 level: administrator, browse, browse+control, browse+control+setup		

	Safe Mode	Authorized user name and password, HTTPS encryption; IEEE 802.1x network access control, IP address filtering
Interface	Audio Input	Support
	Audio Output	Support
	Network	10M/100M
	TF Card	Support
	Program	Support standard Onvif
	Browser	IE8,IE9,IE10,Chrome8+,Firefox3.5+
General	Power	AC24V 40W max
	Working Temperature and Humidity	-40 °C-65°C Humidity<90%
	Protection Level	IP67/TVS 4000V lightning protection
	Dimensions	Φ230 (mm) *350 (mm)
	Weight	4.8kg

Model		HD IP Starlight Auto-tracking IR Speed Dome	
Specification			
Camera	Sensor	1/1.8" Sony Progressive Scan CMOS	1/1.8" Sony Progressive Scan CMOS
	Pixel	2.1M	2.1M
	Image Resolution	Color: 0.002 Lux @(F1.5,AGC ON) Black&White:0.0002Lux @(F1.5,AGC ON) 0 Lux with IR"	
	Resolution	≥1000TVL	
	White Balance	Auto / Semi-auto/Sunshine/Daylight Lamp/Warmlight Lamp/Filament Lamp/Nature Light/Lock White Balance/Manual	
	GC	Auto /Manual	
	S/N	>55dB	
	Noise Reduction	3D	
	WDR	Support	
	Electronic Shutter	1/25-1/100000S	
	Day/Night	Auto ICR	
	Focus	Auto / Manual/ Semi-auto	
	Lens	Focal Length	6-180mm,32X
Zoom		5S	5S
Horizontal Angle		61.2°~2.32°	60°-2°
Near Distance		10~100mm	10~100mm
Iris		F1.5~F4.3	F1.5~F4.8
PTZ	Horizontal Rotation Range	360°continuous rotation	
	Horizontal Speed	0.1°~160°/s (stepless speed)	

	Vertical Rotation Range	-16°~90°auto flip
	Vertical Speed	0.1°-120°/s
	Preset	500
	Auto Cruise	16 group, each group can set 32 preset
	Auto Scan	Support track, horizontal, vertical, frame, whole view and random scan
	Guard Location	Link preset/scan/cruise/pattern
	Power off Memory	Support
	Position Information Display	On/Off
IR	IR Distance	150m
	IR Angle	Zoom matching, far/middle/near
Network	Image resolution	1920×1080
	Frame rate	50Hz: (1920×1080) 25/50fps (1280×960) 25/50fps (1280×720) 25/50fps 60Hz: (1920×1080) 30/60fps (1280×960) 30/60fps (1280×720) 30/60fps
	Video Compression	H.264/MJPEG/H.265
	Audio Compression	G711A/G711U/G726/ADPCM/AAC
	Network Protocol	IPv4,HTTP,HTTPS,802.1x, FTP,SMTP,UPnP,SNMP DNS,DDNS,NTP,RTSP,RTP,TCP/IP,DHCP,PPPoE
	Preview Channel	Max 20ch

	Stream	Triple
	Authority	32 users, 4 level: administrator, browse, browse+control, browse+control+setup
	Safe Mode	Authorized user name and password, HTTPS encryption; IEEE 802.1x network access control, IP address filtering
Interface	Audio Input	Support
	Audio Output	Support
	Network	10M/100M
	TF Card	Support
	Program	Support standard Onvif
	Browser	IE8,IE9,IE10,Chrome8+,Firefox3.5+
General	Power	AC24V 45W max
	Working Temperature and Humidity	-40 °C-65°C Humidity<90%
	Protection Level	IP 67/TVS 6000V, Lightning/ Surge 4000V Protection
	Dimensions	Φ230 (mm) *332 (mm)
	Weight	5.1kg

Chapter 4 Installation Guide

4.1 Preparation

1. Tools:

Please prepare the necessary tools according to specific situations

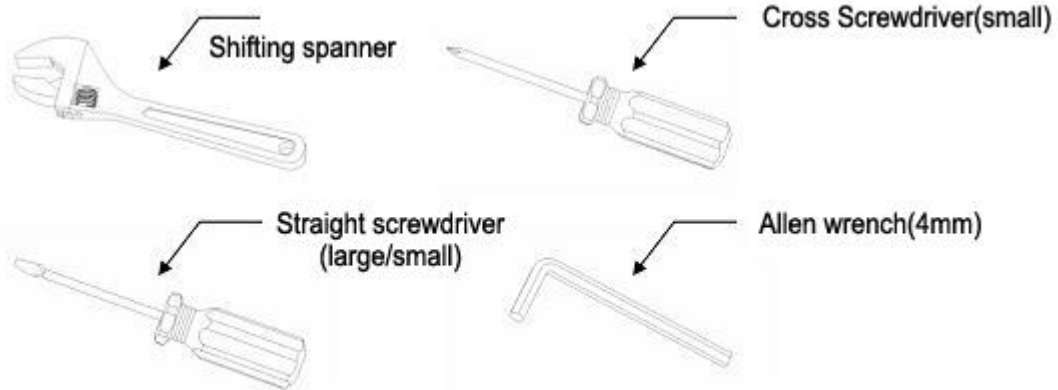

2. Check installation space and address

Check the space is enough to install the speed dome. The wall must be thick enough to install the expansion screws and can bear 4 times the weight of the dome camera itself.

3. Please well keep the whole package

After open the package, please well keep them in case need to return to manufacturer if any problem.

★Note: The non-original package may lead to damage during the transportation.

4.2 Installation

The speed dome supports four types installation as following:

1: Wall mount and dimension:

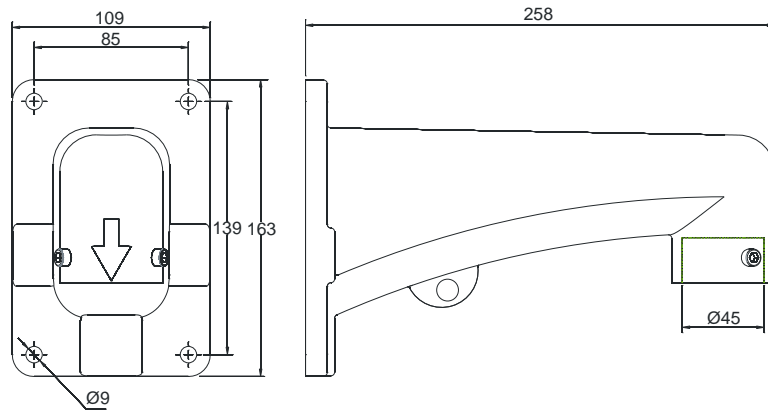

Wall Mount Bracket Dimension

2: Pedant mount and dimension:

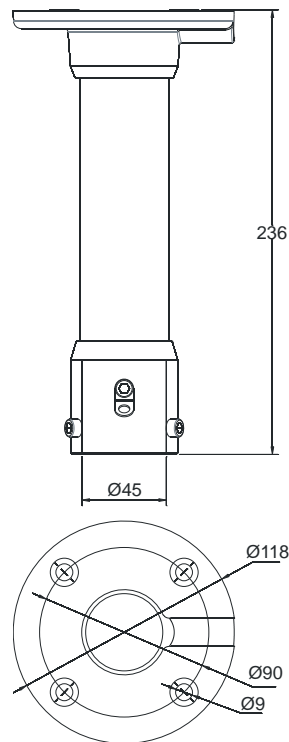

Pedant Mount Bracket Dimension

3: External corner and dimension

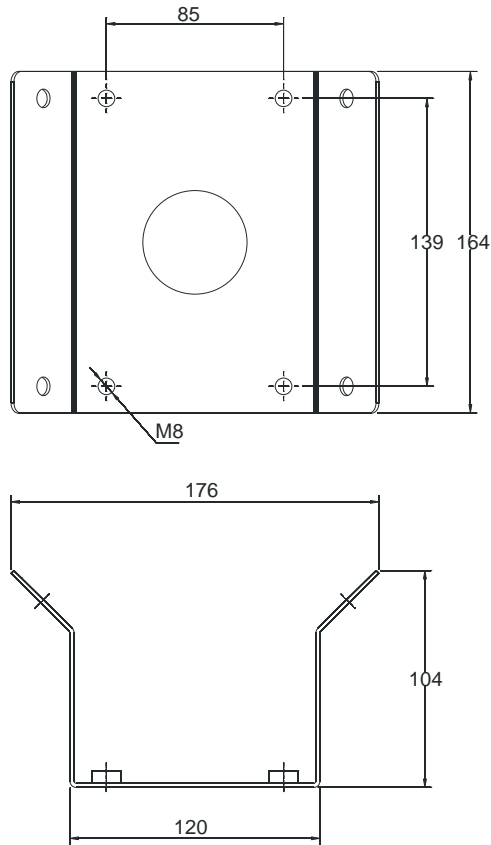

External Corner Bracket and Dimension

4: Pole mount and dimension:

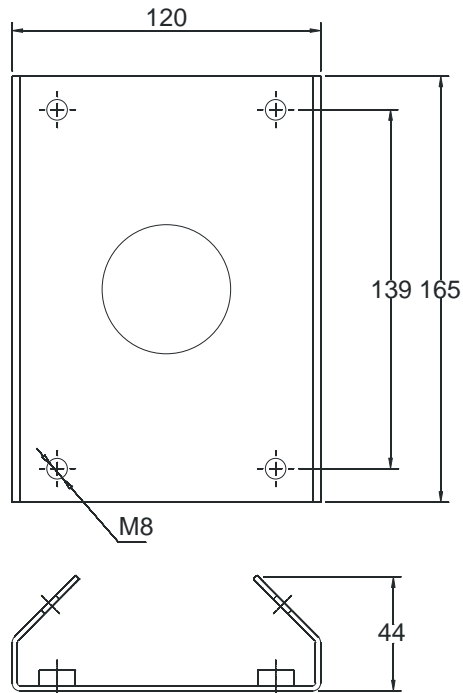

Pole Mount Bracket and Dimension

4.3 Interface Instruction

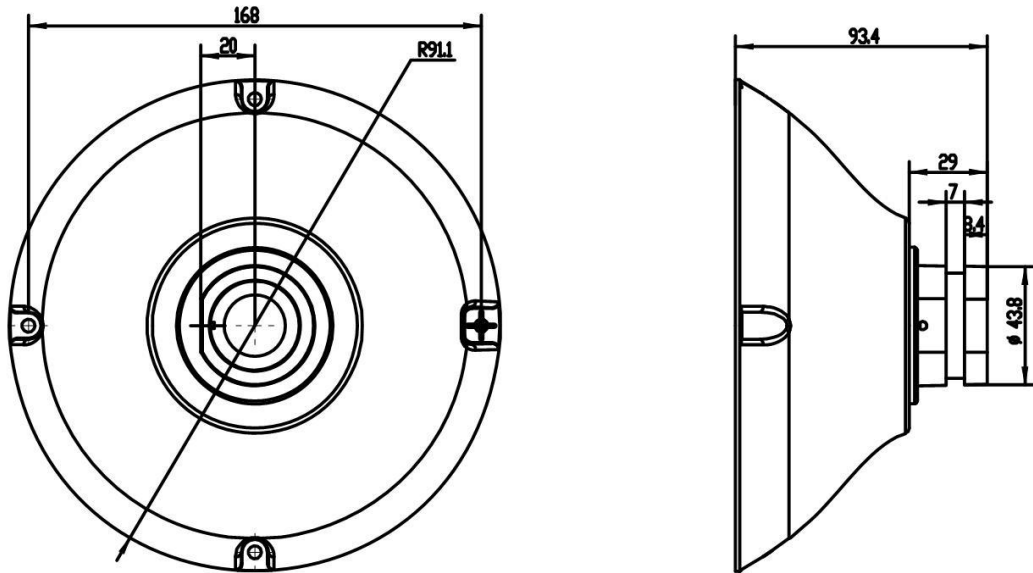

Speed Dome and Bracket Interface Dimension

4.4 Installation Procedures (Take Wall Mount as Example)

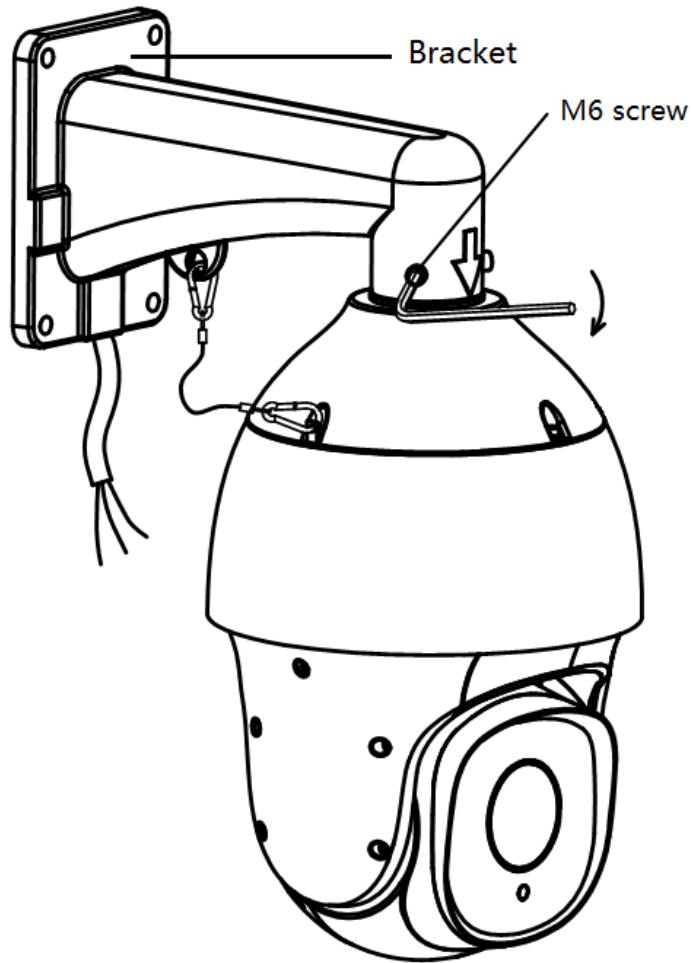

Figure 1

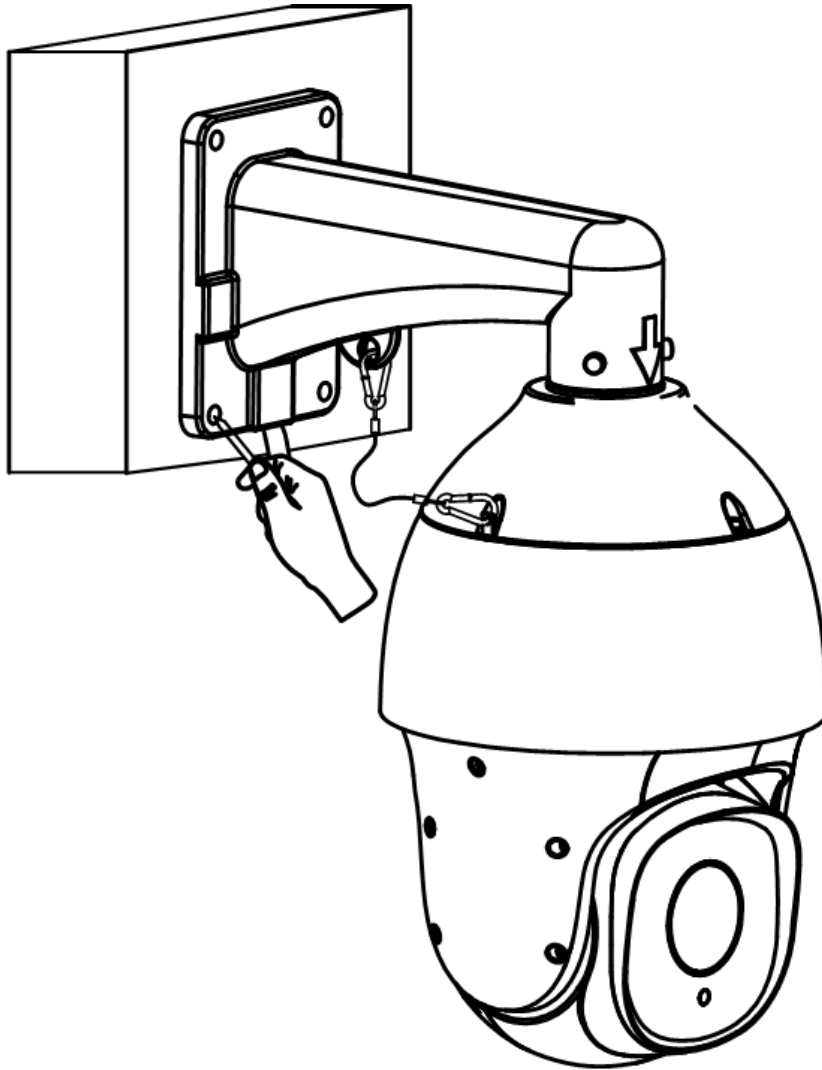

Figure 2

Steps:

Remove the wall mounting bracket and speed dome, and lead the cable through the bracket and set aside to the right position. Aligned the screw holes of speed dome to that of bracket, and use M6 screws to fix. (as Figure 1)

Mark the drill holes position on wall with ink pen for bracket installation, then drill holes and punch the expansion screws in, then fasten the bracket with M8 screws as Figure 2.

Description:

- 1) The wall must have sufficient load-bearing capacity.
- 2) Outdoor installation shall be completely sealed moisture; leads cable should closely along the bracket wiring as Figure 1.

4.5 External Cable Connection Instruction

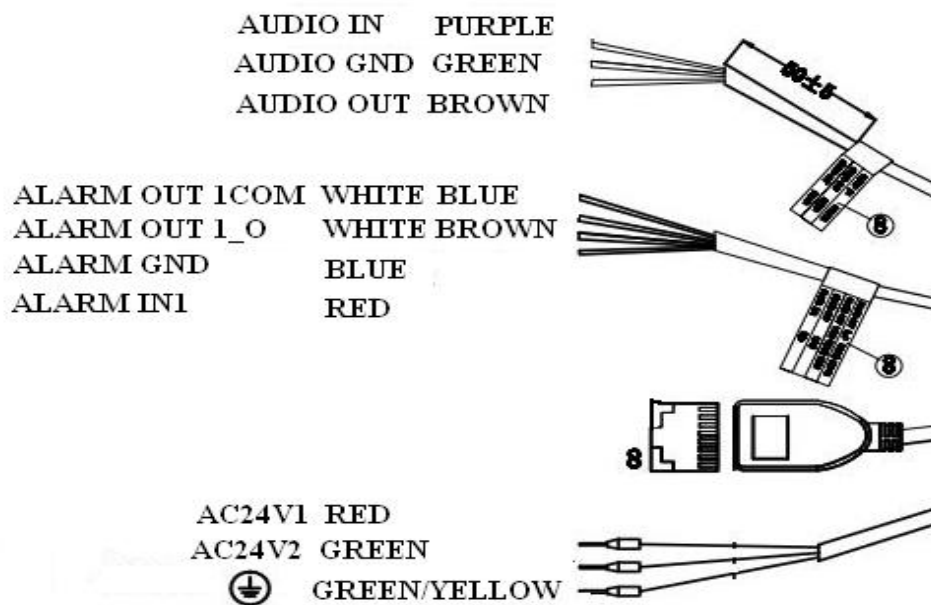

Power Cable:AC24V;

Network: Connect computer or other devices

Audio Cable: Audio input and output can connect mic and speaker

Alarm Cable:Connect external alarm devices;

Note: Please refer to labels on the cables

Chapter 5 WEB Instruction

5.1 System Requirement

The IP speed dome web settings support Windows XP, Win7 system, please make sure right installation and setup of following items:

- (1) Display resolution: 1024 * 768 or higher, color: High Color (32-bit).
- (2) Please make sure the Windows system install the necessary character style.

5.2 Built-in Web Instruction

When using the network video products for the first time, an ActiveX control is needed. Note: please use IE browser of windows and make sure the version above 6.0. Do not use any other

browser except Firefox, Google.

(1) Login IP address and enter to ActiveX download interface.

(2)Download ActiveX and click **【Run】** to install

5.3 Log in

Camera default IP address is:192.168.1.2,please make sure computer and IP camera in the same IP address area.

You need to download Active X plug when first time to use.

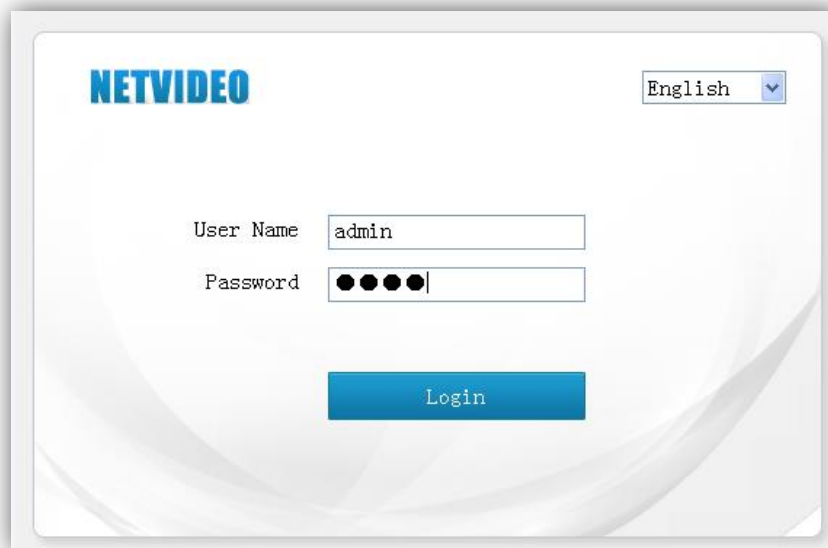

5.4 Preview



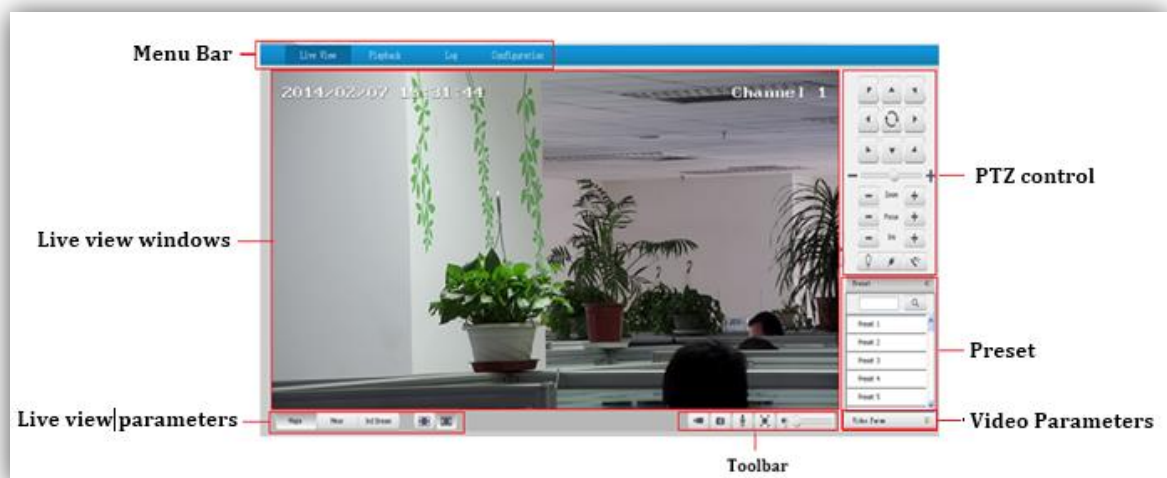







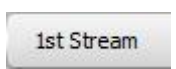

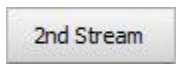

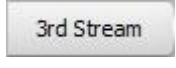
Descriptions of live view page







5.4.1 Live View



Descriptions of live view parameters and toolbar

Icon	Description	Icon	Description
	Major stream		Intercom on/off
	Minor stream		Full screen
	Third stream		Audio on, volume adjustment and mute
	Screen lock		Area Exposure
	Screen adapt to current resolution		Area Focus
	Manual recording on / off, and default storage path is D\NetVideoBrowser\		Digital Zoom
	Manually capture, and default storage path is		Manual Tracking

	D\NetVideoBrowser\		
	Sound alert button		Laser button
	Alarm elimination button		QR code button

- (1) All functions will be available after clicked icons.
- (2) When stream type is <Pure Video>, audio preview is invalid.
- (3) Talkback only support one user at one time, please close this function is the talkback is finished, to avoid other user to use this function.

5.4.2 PTZ control



Direction button is used to control PTZ moving direction, button in the center is to call Scan1



Speed bar is designed to adjust rotation speed, "+" means fast, "-" means slow

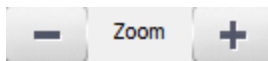

Zoom in /Zoom out

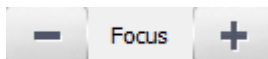

Focus buttons, "-" mean focus on near side, "+" means focus on far side

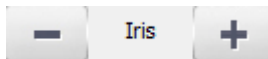

Manually adjust iris.



Preserved for future functions



Wipper



Click to enable Defog function



Click to enable High Light Control function



Click to enable WDR function

5.4.3 Preset position

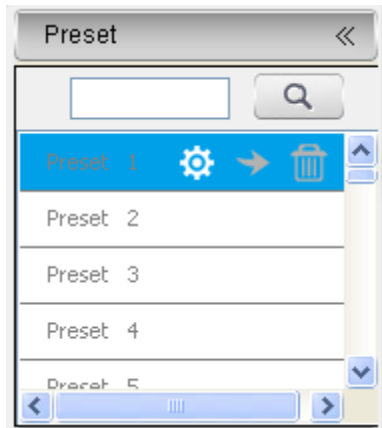

Features: Preset is to save a quick position for PTZ, it contains the horizontal and vertical angle and camera focus etc.

 Search the target preset number.

 Setup preset position.

 Call the preset position.

 Delete the preset position.

Call and Delete functions are only available for existed presets.

5.4.4 VCA Action

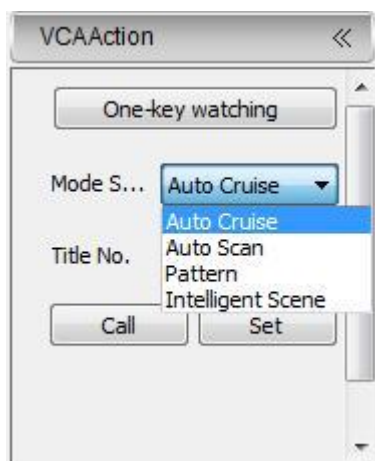

<One-key watching>: Click the button of One-key watching and the current scene will be set as the watching preset (default preset 1). Start the watching function at the same time.

Mode Selection: Select target mode, <Auto Cruise>,<Auto Scan>,<Pattern>, < Intelligent

Scene >

<Call> call automatic action

<Set> set automatic action

5.4.5 Video parameter

(1)<Default> to resume the default settings.

(2)According to network situation you can choose preview mode from <Low bandwidth>, <High quality>

 Brightness

 Contrast

 Satruation

 Hue

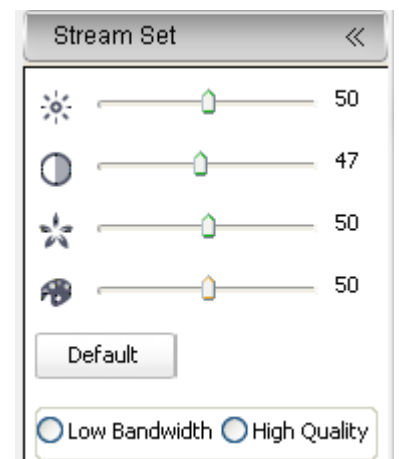

For details, see the configuration page

5.4.6 right-hand button

Click the right-hand button on the video image and the following function options will be ejected out:

<Disconnect>: Disconnect the video code stream connected currently.

<E-zoom>: The function of it is the same as the digital zoom button of the preview interface.

<3D locate>: Adjust the scene needing to be monitored into the video center through the mouse click control.

<Flip>: Control the video image to reverse for 180 degrees.

<Snap Shot>: Cut out the current preview image and store it into the memory card of the equipment. It is applicable to the equipment with the memory card installed at the front end.

<Defog>: Start the automatic defogging and after the defogging, the function will be

closed down automatically.

5.5 Playback

On the playback interface, The user can view the video file on specific date. While the operation of snapshot, film editing, etc. is available. Read the following table for the basic operation:

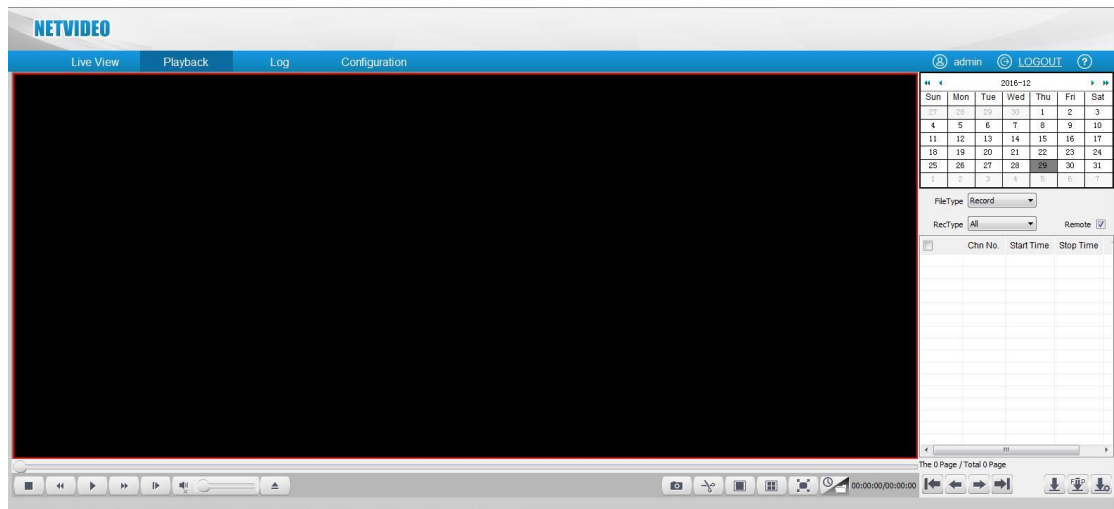

Stop recording



Speed down in 1/2X, 1/4X, 1/6X and 1/8X



Play/Pause



Speed up in 2X, 4X, 6X and 8X



Playback by frame



Audio on/off



volume adjustment and mute



Click browse button to select target video file



Capture, and default storage path is
D:\NetVideoBrowser\



Clip video files, and default storage path is D:\NetVideoBrowser\



Single screen



Playback in 4 screen at the same time



Double click the screen or click  to enter full screen status. In full screen, double click or enter <Esc> to quit full screen



playback switch mode

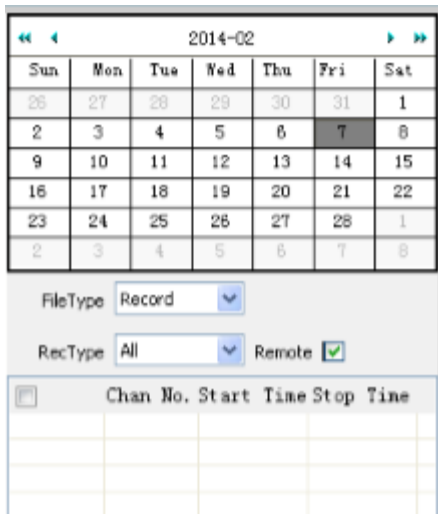

Click the date in calendar to choose the files according to conditions



Mode switching : Playback includes time shaft mode and document mode, switching by clicking





means in the document mode, and



shows in the time shaft mode.

In time shaft mode user can drag to choose recording files, and then click  to play, click  to zoom out the time shaft and click  to zoom in.

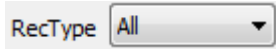
In document mode user can operate it according to document type, recording type, and remote enquiry. The button functions as below :

- | | |
|---|------------------------------|
| Icon | Description |
|  | Select file type |
|  | Select Video type |
| <input checked="" type="checkbox"/> Remote | Check to search remote files |
|  | Jump to first page |



Jump to previous page



Jump to next page



Jump to the last page



Download recording files



Download files into FTP server



Preview download status

5.4 Log

No.	Channel	Type	Time	User	Content
1	Channel 1 1st Stream	System	2016-12-29 22:30:54	--	Connect channel 1 main stream, mode 1, from:192.168.1.114#
2		User	2016-12-29 22:30:47	--	User (Admin) log on from 192.168.1.114 successfully!
3	Channel 1 1st Stream	System	2016-12-29 22:30:42	--	Disconnect channel 1 main stream, mode 1, from:192.168.1.114#
4		User	2016-12-29 22:30:42	--	User (Admin) log off from 192.168.1.114 successfully!
5		Warning	2016-12-29 22:30:42	--	Top command socket error!
6		Warning	2016-12-29 22:29:29	--	Wired network is up
7		User	2016-12-29 22:25:20	--	User (Admin) log on from 192.168.1.114 successfully!
8	Channel 1 1st Stream	System	2016-12-29 22:25:20	--	Connect channel 1 main stream, mode 1, from:192.168.1.114#
9		User	2016-12-29 22:22:32	--	User (Admin) log off from 192.168.1.114 successfully!
10		Warning	2016-12-29 22:22:25	--	Wired network is down!
11		System	2016-12-29 22:19:44	--	DOME Log:DOME_DAY_NIGHT, Enable=0, Para=0, 2, 0, 0!
12		System	2016-12-29 22:19:44	--	DOME Log:DOME_DAY_NIGHT, Enable=0, Para=2, 2, 0, 0!
13		System	2016-12-29 21:57:45	--	DOME Log:DOME_DAY_NIGHT, Enable=0, Para=0, 2, 0, 0!
14		System	2016-12-29 21:57:44	--	DOME Log:DOME_DAY_NIGHT, Enable=0, Para=1, 2, 0, 0!
15		System	2016-12-29 21:56:07	--	DOME Log:DOME_MIN_FOCUS_LENGTH, Enable=1, Para=600, 2, 0, 0!
16		System	2016-12-29 21:55:55	--	DOME Log:DOME_MIN_FOCUS_LENGTH, Enable=1, Para=50, 2, 0, 0!
17	Channel 1 1st Stream	System	2016-12-29 21:55:19	--	Connect channel 1 main stream, mode 1, from:192.168.1.114#
18		User	2016-12-29 21:55:12	--	User (Admin) log on from 192.168.1.114 successfully!
19	Channel 1 1st Stream	System	2016-12-29 21:55:05	--	Disconnect channel 1 main stream, mode 1, from:192.168.1.114#
20		User	2016-12-29 21:55:05	--	User (Admin) log off from 192.168.1.114 successfully!
21		Warning	2016-12-29 21:55:05	--	Top command socket error!
22	Channel 1 1st Stream	System	2016-12-29 21:42:27	--	Connect channel 1 main stream, mode 1, from:192.168.1.114#
23		User	2016-12-29 21:42:21	--	User (Admin) log on from 192.168.1.114 successfully!
24	Channel 1 1st Stream	System	2016-12-29 21:42:15	--	Disconnect channel 1 main stream, mode 1, from:192.168.1.114#
25		User	2016-12-29 21:42:15	--	User (Admin) log off from 192.168.1.114 successfully!
26		Warning	2016-12-29 21:42:15	--	Top command socket error!

(1) <Channel No> Select target channel

(2) <Log Type>

All/system/warning/alarm/operation/user/others

(3) <Start Time> Select start date and time.

(4) <End Time> Select end date and time.

(5) <Query> Get a log list.

(6) Check logs by <First Page><Pre Page><Next Page><Last Page> and <Jump To>target page.

(7) <Export Current Page> to export logs, and default save path is D\NetVideoBrowser.

(8) <Export All Page> to export all the pages query, and default save path is D\NetVideoBrowser.

Chapter 6 Configuration

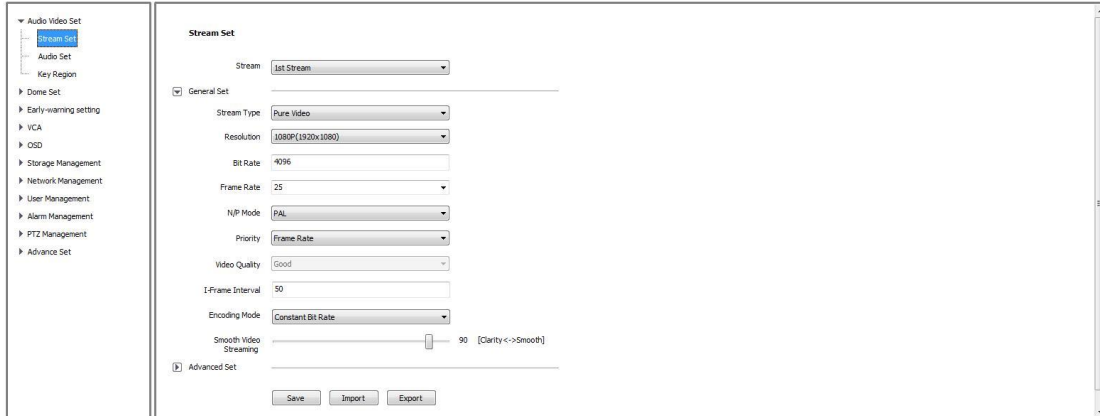

6.1 Audio Video Set

6.1.1 Stream Set

General Set

(1) **<Stream Type>** <Audio Video> / <Pure Video>.

(2) **<Resolution>** 4CIF/VGA/720P/960P/1080P/QXGA.

(3) **<Bit Rate>** show stream rate for the video, unit is Kbps. When choose <Static code rate> , <Bit Rate> stand for actual rate of the stream. When choose <Dynamic code rate>, <Bit Rate> show the max stream rate, range from 32 ~ 8000Kbps.

(4) **<Frame Rate>** 1/5/10/15/25/30fps optional.

(5) **<N/P Mode>** Select <PAL> or <NTSC>.

(6) **<Priority>**

<Frame Rate> Fluency first.

<Quality> Video quality first.

(7) **<Video Quality>** only be activated when choose <Dynamic code rate> in <Encoding Mode>. **<Video Quality>** <Best>, <Better>, <Good>, <Normal>, <Poor>, The better quality the more stream and bandwidth occupation.

(8) **<I-Frame Interval>** To set the interval time for each two I frame. (I frame is the key frame in the video stream).

(9) <Encoding Mode>

<Constant Bit Rate> In constant bit rate mode, there is little variation in video data volume, the bandwidth is stable.

<Variable code rate> In variable bit rate mode, video data volume varies according to the complex of video image. Single scene can save more bandwidth.

(10) <Smooth Video Streaming> Setting the ratio of I and P frame. More smooth, more fluent in dynamic scenes, and more clear of the video in static scenes.

Advance Set

(1) <Video Encoding> <H.264>, <H.265> and <Motion JPEG>.

(2) <S+> adaptively encode according to the specific scene, further improve the compression performance and reduce the storage space.

(3) <Extended Code> Available when selected <H.264>, there are <baseline>, <main profile>, <high profile> for selection.

(4) <Encrypt Type> Add password for the channel.

<Encrypt Password> Enter password.

<Password Confirm> Confirm the password. Click <Save> to enable.

(5) <Electronic Image Stabilization> Select <Disable> or <Enable>.

(6) <SVC> Select <Disable> or <Enable>.

(7) <Save> Save and enable the setting.

Stream Set -Export

<Export> backup the configuration file.

Stream Set -Import

<Import> import the backup file for parameter configuration.

6.1.2 Audio Set

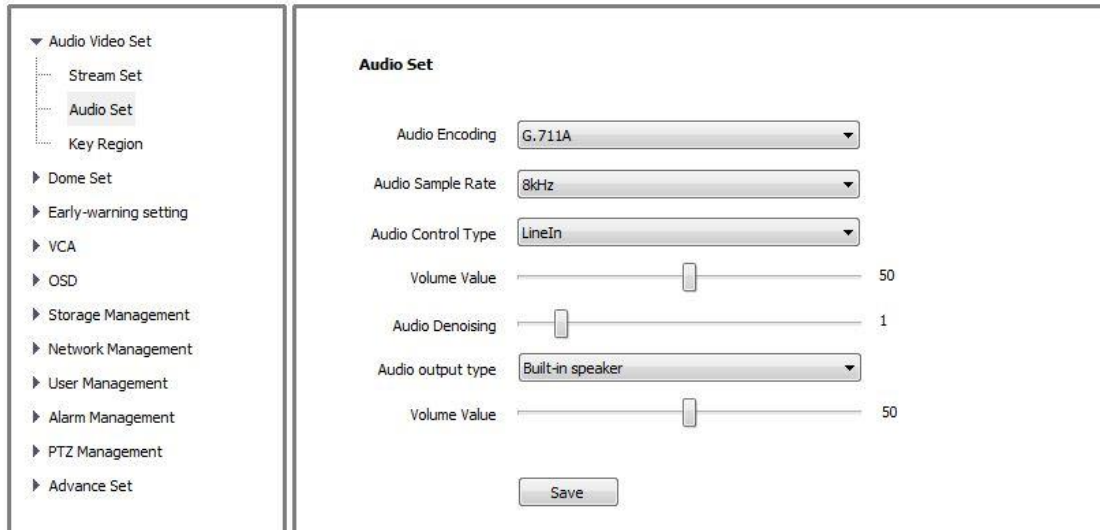

(1) <Audio Encoding> select audio compression type.

(2) <Audio Sample Rate>

<8k>, <32k>, <64k> optional.

(3) <Audio Control Type>

Select <LineIn> or <MicIn>, When the input source signal is weak, select <MicIn>, when the input signal source is strong, select <LineIn>.

(4) <Volume Value> Voice volume setting

(5) <Audio Denoising> Denoising level setting, default value is 1, the larger the number is, the higher the audio denoising level is. Audio denoising function is shut down at 0.

(6) <Audio export type > Select the audio output type in the drop-down box: <Built-in speaker>, <External sound source>, <Close>.

(7) <Save> save and enable the setting.

Note: some models need reboot after saving the setting.

6.1.3 Key Region

<Key Region> To have better image quality for some regions on the video, there are 7 regions settable for 1st Stream and 2nd Stream.

(1) <Start to Draw >

Use the mouse to draw the key region on the video.

(2) <Delete Region>

delete the drawn regions.

(3) <Selezione Tipo> Select <Fixed Area> or <Rilevamento Dinamico>

Dynamic tracking mode selected, Dynamic tracking in key zone is available.

(4)<Upgrade Level><Best>,<Better>,<Good>,<Normal>,<Poor> the higher the level, the better the details.

(5)Click<Save> to enable.

6.2 Dome Set

6.2.1 Image Set

Set video image parameter in this page.

The system provides 4 video templates for different application, all the video parameter can only be revised and saved in the template.

(1) <Current> Select current template.

(2)<Name>show the name of the current template, it can be revised.

Image Adjustment

(1)<Brightness>

Range from 0 to100.

(2)<Contrast>

Range from 0 to100.

(3)<Saturation>

Range from 0 to100.

(4) <Hue>

Range from 0 to100.

(4) < Sharpness >

Range from 0 to255.

Exposure Set

(1)<Auto Expoure Speed>

Range from 0 to100. The larger the value, the faster the exposure speed

(2)<Expouse>:<Auto><Manual><Shutter Priority><Iris Priority>

(3)<Max Gain Set>:The maximum gain value adjustment can modify the image brightness compensation under the low luminance; the higher the gain value is, the higher the improvement of the brightness will be, but the larger the noisy point will be.

(4)<Target Brightness>: The brightness of the video image can be set by adjusting the target brightness. The larger the value is, the higher brightness of the video monitoring image will be, and the larger of the noisy point will be under the low luminance.

Focus Set

(1)<Focus Mode>:<Auto><Manual><Semi-auto>. Under <Semi-auto> mode, one PTZ action triggers one focus, and there is no automatic focusing when the same scene image changes.

(2)<Min Focus Disance>: The minimum focusing distance can be set, and it can be set as 6m for the outdoor large-scale scene and 1.5m for the indoor scene.



Smart IR

<Smart IR>:Under the infrared condition, this function can prevent nearby objects from overexposure due to the infrared opening of the dome camera.

Backlight Set

<WDR><Close><Blacklight Compensation><WDR Auto><WDR Manual> In BLC mode, check Backlight Set, then select target in the preview window on the left. can effectively solve the dark foreground target due to the underexposure.

<HLC>:<ON><OFF> Hard light can be restrained by turning HLC on. The HLC level is adjustable. When there is strong light, this function can suitably inhibit the strong light and make the video image clear. The strong light inhibition level can be adjusted according to the actual scene.

White Balance

<Auto>,<Semi-auto>,<Sunshine>,<Daylight Lamp>,<WarmLight Lamp>,<Nature Light>,<Lock White Blance>,<Manual>.When selected<Manual>,there will be 2 sliding blocks to set the white balance, R stand for red gain and B stand for blue gain.

Image Enhancement

<Image Style>:<Self-adaption><Nature><Bright><Gentle><Bright-coloured>

<Indoor/Outdoor>:<Indoor><Outdoor>

<Defog>:<Off><On>

<Digital Denoise>:<Close><Ordinary Mode><Exper Mode>. The advanced 3D image noise reduction technology can effectively reduce the image noisy point and make the image softer and more exquisite. The noise reduction includes the ordinary mode and expert mode.

<Denoise Level> range from 1~255, The higher the level, the smaller the grain, and accordingly more likely to have tails on video.

< Save>to save and enable the setting.

< Default>to recover the defaults setting for the target template.

6.2.2 Schedule

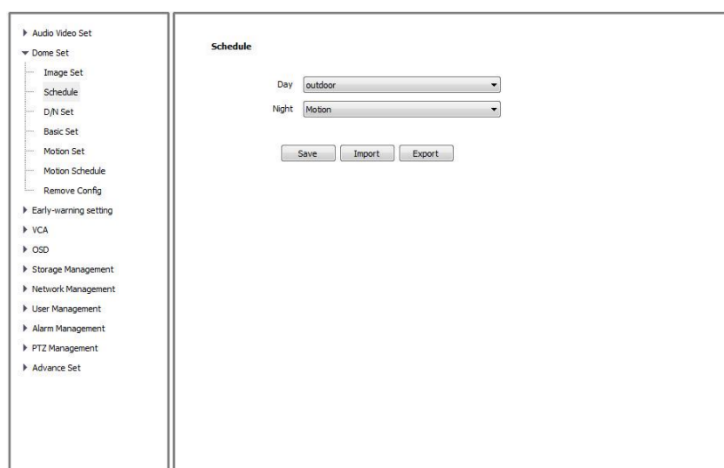

The Schedule can be used for day and night, and the equipment can switch the template automatically according to the external environment..

<Schedule> has Export and Import function, operation is the same as < Stream Set >.

6.2.3 D/N Set

< **Color to B/W Set** >: It can be set as night, daytime, timing and auto. Under the auto mode, day-night image will be switched automatically.

<**Sensitivity**>: Under the auto mode, the sensitiveness of day-night switching can be set as low/medium/high.

< **Sunrise Time** >: Under the timing template, the timing from black to color can be set.

< **Sunset Time**>: Under the timing template, the timing from color to black can be set.

6.2.4 Basic Set

The screenshot shows the 'Basic Set' configuration page. The left sidebar contains a tree view with 'Basic Set' selected. The main area is titled 'Basic Set' and contains a 'Basic Information' section. The settings are as follows:

- Basic Information
 - Auto Flip Enable
 - Preset Freeze Enable
 - Enable Digital Zoom
 - Enable Preset Snapshot
 - Enable Proportion Zooming
 - Enable Scan Record
 - Enable Mode Record
- Control Speed: Middle
- Zoom Speed Level: High
- Temperature Control Mode: Auto
- Auto Stop-time(s): 30
- Preset Speed: Middle
- P/T First: Network
- Priority Delay Time(s): 0
- Standby Action: Preset 1 Enable
- Standby Time(s): 30
- Power-lost Memory Mode: 30Second

At the bottom, there is a 'Save' button and a 'Title' field.

6.2.4.1 Basic

Basic Information

<**Auto Flip Enable**> Enable for 0~180°, disable for 0~90°.

<**Preset Freeze Enable**> On/off preset freeze. The image won't be switched until the preset adjustment is done.

<**Enable Digital Zoom**> On/off digital zoom. When it is on and optical zoom is maximum, digital zoom will be enabled

< **Enable Preset Snapshot** > On/off snapshot on preset, when it is on and preset is enabled, the snapshot will be saved in camera

< **Enable Proportion Zooming** > on/off proportion zoom, when it is on, the speed will be adjusted to the zoom value, vice versa.

< **Enable Scan Record** > on/off scan recording, when it is on, it will be recorded when scanning and the recorded file will be saved in camera.

<**Enable Mode Record** > on/off pattern path recording, when it is on, it will be recorded when it is in pattern path and the recorded file will be saved in camera.

<**Tilt Angle Adjustment**> Set the tilt angle for speed dome camera, range from "0"to"-11" degree. High speed dome: 0 to -15, V3 IR speed dome: 0 to -16

<**Control Speed**>

Set limit for the max operation speed, high/medium/low for selection.

<Zoom Speed Level> Zoom speed level setup, the default is middle, the higher the level is, the faster the manual zoom speed.

<Temperature Control Mode>**<Auto>**and**<OFF>**、**<DEFOG>**

<Auto Stop-time (s)> Set the time period for the speed dome camera to stop PTZ movement since the last operation. It can be set to be 5/15/30/60s.

<Preset Speed> Set the preset speed for speed dome camera, there are high/medium/low for selection.

< P/T First >: Ethernet and RS485 interfaces. Check PTZ priority as required.

< Priority delay time(s)>: Delay time between two modes. For example: If the delay time is set as 30s, when switching from Ethernet to RS485, speed dome cannot be controlled within 30s.

<Standby Action> It is to define the action of speed dome camera when it is idle. There are 4 options preset#1, scan#1, cruise#1 and pattern#1.

<Standby Time (s) > enable standby time setting. There are 30s,60s,300s,600s and 1800s for selection.

< Power-off memory mode > Automatically save the time and PTZ setting when power is off. When it is on, PTZ speed dome will be in the last saved setting.

<save> save and enable all the setting.

6.2.4.2 Title

<Title Type> Preset, Scan, Cruise, Pattern and Zone No.

<Title No.> Preset number range from 1-32, Scan number range from 1-8, Cruise number range from 1-16 Pattern number range from 1-8, Zone Number range from 1-8.

<Title Name>Set title name.

<Dwell Time> Title display on the screen, options 2s,/5s/10s/disappear/keep.

<Display Coordinate Direction> check to display the movement coordinates.

<Display Title Background> check to display title background.

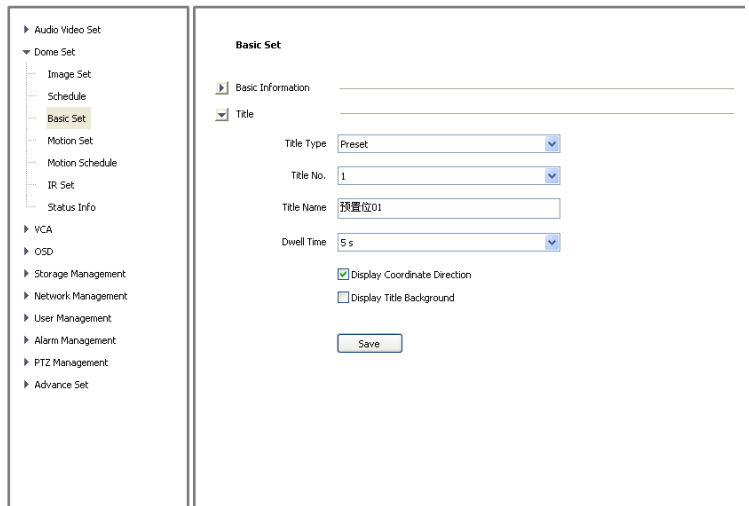

6.2.5 Motion Set

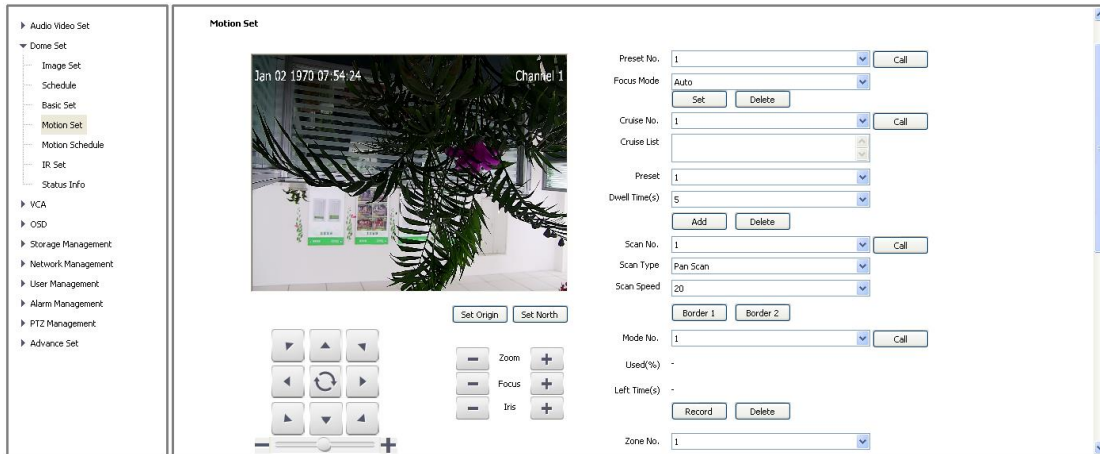

6.2.5.1 Preset

<Preset No.> The dome camera can support 500 preset totally, wherein the non-special preset includes 1-64 and 100-500, and the user can set these preset.

<Focus Mode> Focus mode for preset can be auto/manual.

<Set> Move to target position and press <Set> to save as preset position.

<Delete> Delete the target number of preset position.

<Call> Speed dome camera will move to the target preset position.

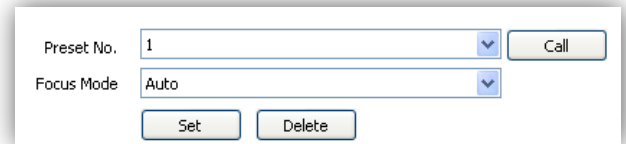

6.2.5.2 Cruise

<Cruise No.> Speed dome camera supports 8 cruises, number from 1-8

<Cruise> show how many presets in the cruise.

<Preset> Only preset number 1-64 and 100-255 are available, click **<Add>** to add the preset into cruise list.

<Stay Time(S)> Set interval time between two presets, rang from 1-60 seconds.

<Add> Add presets into cruise list.

<Delete> Remove preset from the cruise list.

<Call> Activate the speed dome to move follow the presets in cruise list.

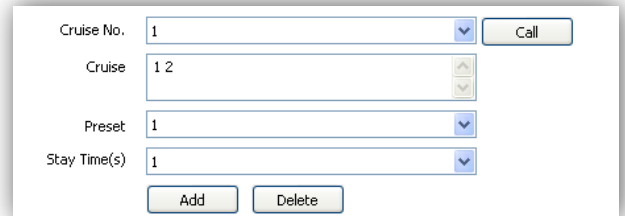

6.2.5.3 Scan

<Scan No.> The speed dome supports 8 Scans, number from 1-8

<Scan Type> Pan Scan, Auto Scan, Frame Scan, Random Scan, Tilt Scan and Spiral Scan.

<Scan Speed> Set speed for Pan Scan, Auto Scan, Tilt Scan, Full Scan and Spiral Scan.

<Border 1> Left border of the Scan.

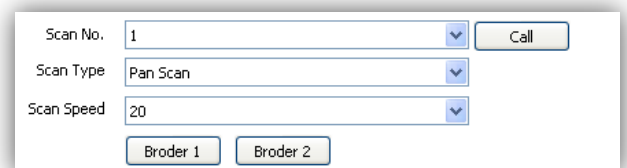

<Border 2>Right border of the Scan.
 <Call>Activate scan movement of the speed dome.

6.2.5.4 Pattern

<Pattern No.>The speed dome camera supports 8 pattern tour, number range from 1-8.

<Used(%)> Show percentage used for operations in one pattern tour.

<Left Time(s)> Show the time remaining in the pattern record process. (The speed dome camera supports up to 180s)

<Record> Start pattern tour recording

<Delete> Delete the target pattern.

<Call> Activate the speed dome camera to move following the pattern tour.

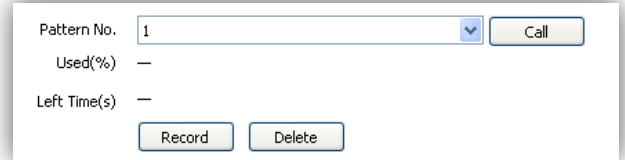

6.2.5.5 Zone No.

<Zone No.>The speed dome camera supports 8 zones, range from 1-8.

<Left Border> Move the speed dome camera to the target position and set it as the left border of the zone.

<Right Border> Move the speed dome camera to the target position and set it as the right border of the zone.

<Delete>Delete the target zone.

<Set Origin>Move the speed dome camera to the target position and set it as original point of the coordinate.

<Set North>Move the speed dome camera to the target position and set it as north direction of the coordinate.

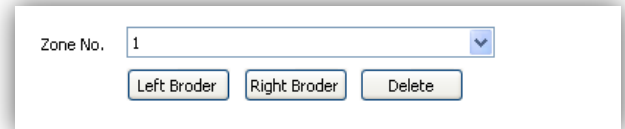

6.2.5.6 Enable Limit

<Enable Limit.> The movement of PTZ will be limited in specific area when it is checked.

<Limit Status> showing if the limit status is on or off.

<Left Border> Hit the button, there will be assistance message on the preview window on the left showing how to set up up-and-down, and left-and right border. Drag the up and down border to the same location to skip the vertical border setup.

<Delete> Delete border setting.

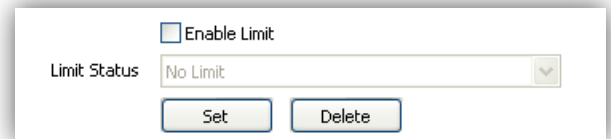

6.2.6 Motion Schedule

Activate different motion (Presets, Scan, Cruise and Pattern) for different time period.

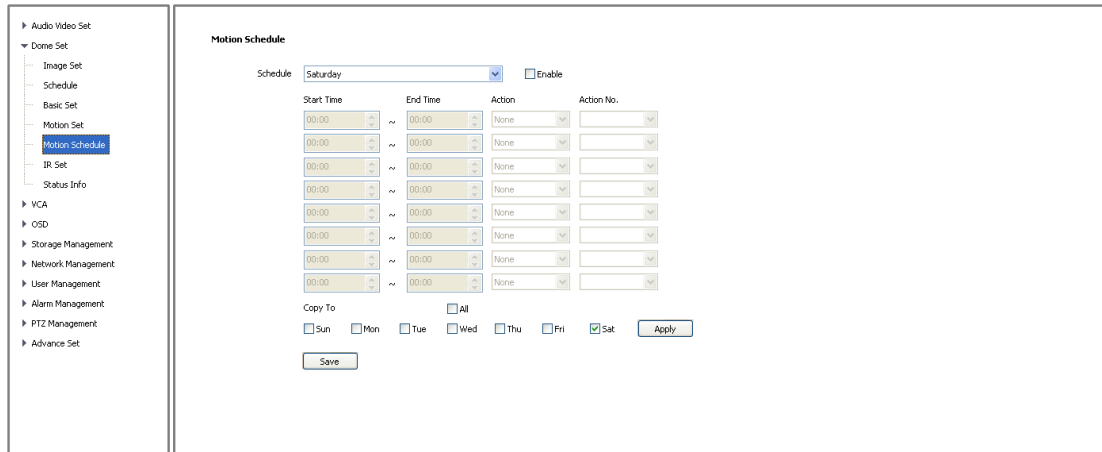

<Enable> Enable the setting.

<Start Time>Start time for the motion.

<End Time>End time for the motion.

<Action> Set the functions executed in the current time period as: None, preset, scan, cruise, mode path and alarm output..

<Action No.>Motion number, Preset 1-8, Scan 1-4, Cruise 1-4, Pattern1-4.

<All>Enable every day in a week, including Saturday and Sunday.

<Apply>Click to copy the configuration to the selected day.

<Save>Save all the setting.

6.2.7 Fill light setting

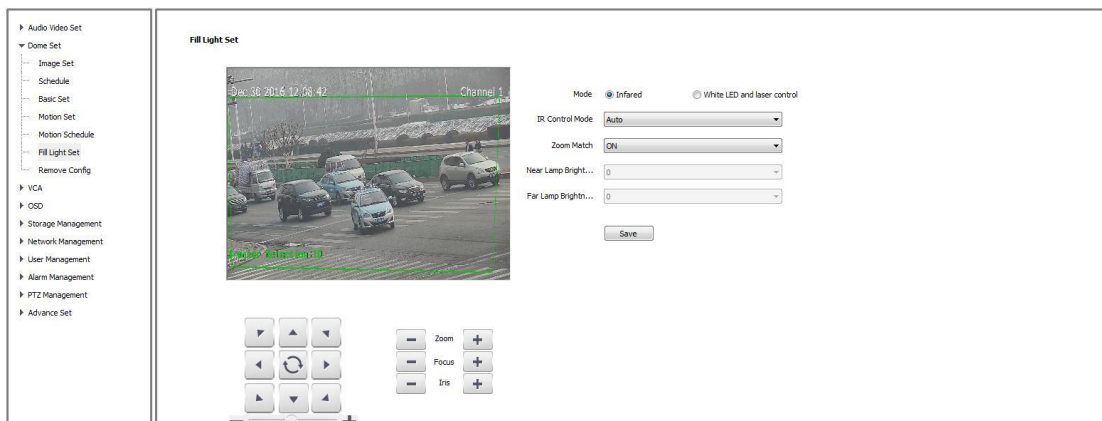

For the <Mode>, Select <Infrared> and < White LED and laser control> mode according to the actual demand;

< White LED Control Mode>: The white-light sources control mode includes automatic, manual starting and automatic closing.

< IR Control Mode>: The infrared lamp control mode includes automatic, manual starting and automatic closing.

< Zoom Match>: When selecting the <ON> mode, the brightness and power of infrared lamp are matched with the camera irradiation distance.

<Near Lamp Brightness> Disable zoom match, set the Near lamp brightness level, range from 0

to 10.

<Far Lamp Brightness> Disable zoom match, set the far lamp brightness level, range from 0 to 10.

<Save> Save all the setting.

Notes:

1. the light distance for white light lamp is 30 meters, when the variable magnification is over 30 meters, turn on the white light lamp manually to fill light is not recommended.
2. For the model of the white light lamp, indoor and outdoor monitoring, if the near scene (2 to 3 meters) has a large reflective object environment, it is recommended turn off the white light lamp to avoid the repeated turn on/off of the light supplement lamp caused by the strong light reflection that will affect the image effect.

6.2.8 Remove Config

In the configuration clear interface, including select all, clear all preset, all cruise route, all scanning, all location limitation settings, standby operations, all mode path, all regional instructions, select the items to be cleared, click the clear button to clear the corresponding PTZ configuration.

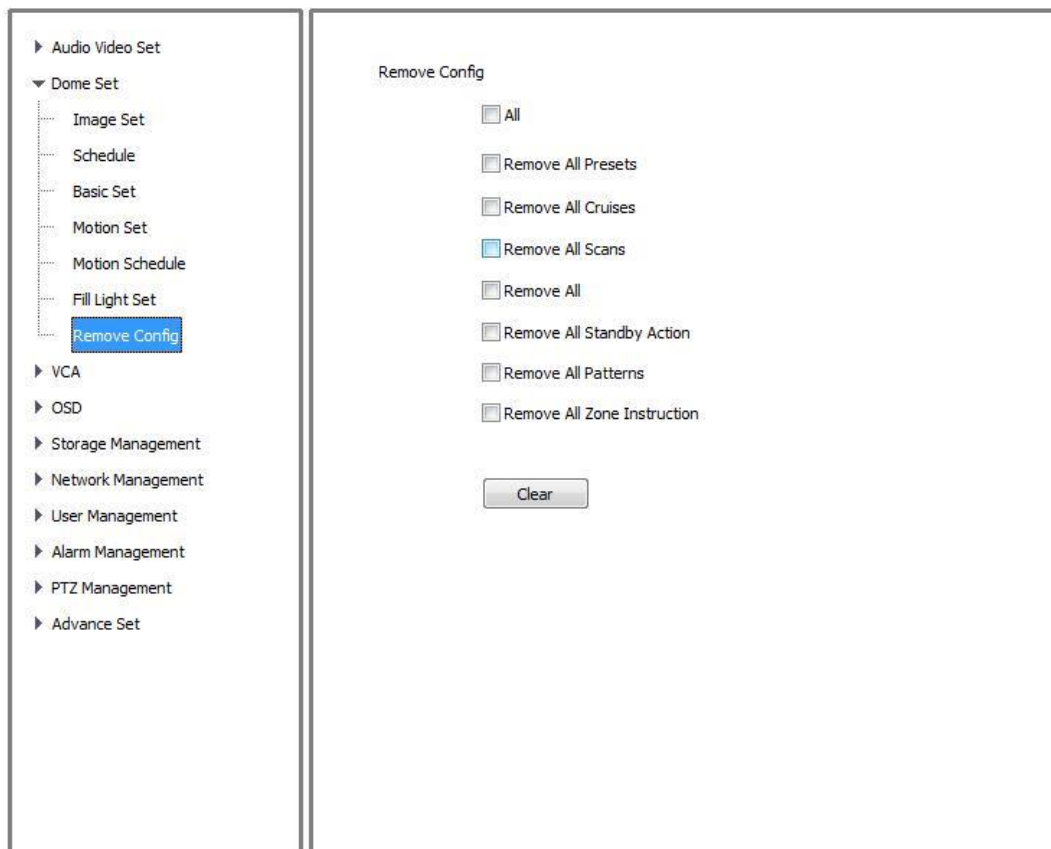

6.4 Early-warning setting

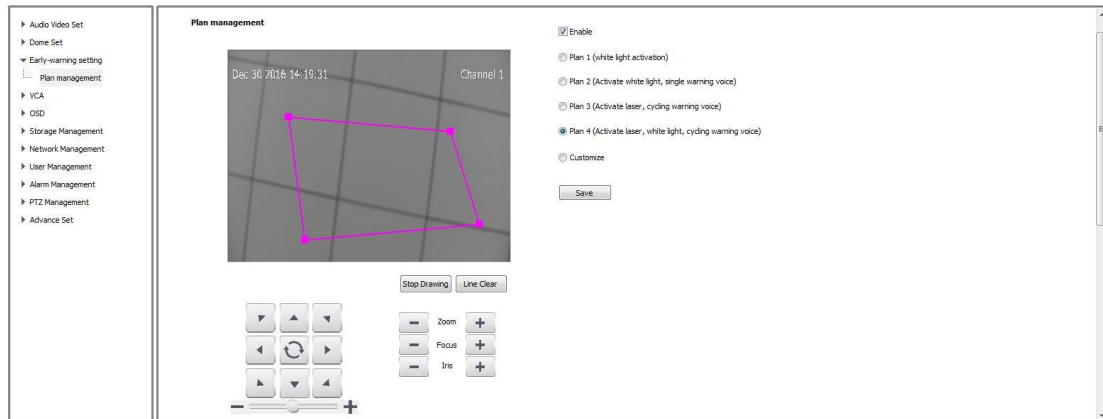

In the Early-warning setting interface, the user can select the Early-warning plan according to the actual situation or preference. The dome camera has 4 plans for selection, and also provides the user-defined plan.

When the user selects the user-defined plan, the selected scene can be set, including the rule name, trigger target, deployment time setting, linkage type and others; after saving the finished settings, click next step, and it will be linked to the cruise setting interface.

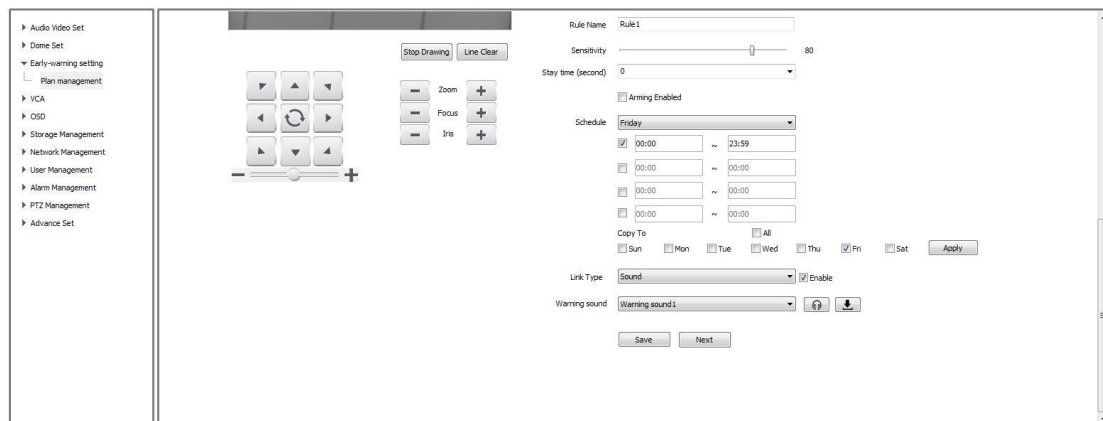

< **Link Type** >: The alarm output, video recording, snapshot, audio, laser, white light , linkage tracking can be selected, and the selected items will come into operation after being checked.

< **Output Port** >: When setting the linkage alarm output, select the appropriate output port according to the needs.

<**Channel selection**>: When setting the linkage snapshot and linkage video recording, select the appropriate channel according to the needs.

<**Sound**>: When setting the linkage sound, the user can select different <Alarm sound> or <User-defined> audio; the <User-defined> audio can be modified by the supporting tools in the help document -> download tools.

When <Play> the linkage sound, after selecting the <Alarm sound>, click the play button for local, remote audition (need to turn on the built-in loudspeaker) to confirm the needed alarm sound.

Description:

1.After the laser is turned on for continuous 300 seconds, the laser will be turned off automatically.

line can work with the algorithm above the transverse line simultaneously.

6.3.2.1 Behavior Analysis

Below are setting operation for different type of analysis after Selected <Behavior Analysis>:

(1)Event Set --- Tripwire/Perimeter/Double Tripwire

<Detect Mode> For <perimeter> detection, include <Intrusion>/<Enter>/<Leave>.

<Intrusion> alarm when object come in/out.

<Enter> alarm when object come in.

<Leave> alarm when object go out.

<Max time interval> Set up the maximum time interval, which shows the time interval to pass through two rule lines continuously

<Min time interval> Set up the minimum time interval

<Percentage> The proportion of the width of the target in the whole picture.

<Show Alarm Count>show total alarm times.

<Show Alarm Rule>show defined tripwire/perimeter on video.

<Display Target> Checked to show target frame

<Two-way Alarm>when selected <Tripwire>, choose the "two-way alarm", then two directions cross will both trigger alarm.

<Rule Clear>clear current rule.

<Save>Save and enable the VCA setting.

After clicking the save button, click the next step, and it will link to the alarm setting interface.

<Linkage Tracking> or <Panorama Tracking>

Tips: <Linkage Tracking> option is only available when you check <Behavior Analysis>

<Arithmetic > configure <Intelligent Tracking>

<Longest Track Time> Set time limitation (seconds) how long the PTZ follow the object. And then it will go back to standby position.

When selecting linkage tracking, set the tracking rate. By adjusting the angle and magnification to determine the target screen in the need to monitor an appropriate ratio, the recommended target screen height of 1/2 or more. , Click to set the tracking rate.



(2)Event Set ---Object Abandone

1. Select the rule number, and name the rule name; select to enable the rule
2. Draw the item left over area and click <Start to draw> button to draw the area. Click the left mouse button to draw the turning point or end point of the line and click the right mouse button to finish the drawing
3. Set the alarm time: it means that when the time of the target under the lost state reaches the alarm time, it will trigger the alarm.
4. Set the sensitivity: the greater the value, the higher the sensitivity will be.
5. Set whether to display the alarm statistics, alarm rules and the target or not.
6. After clicking the save button, click the next step, and it will link to the alarm setting interface.

The screenshot shows a configuration window for a rule named 'Rule1'. The 'Arithmetic' dropdown is set to 'Behavior Analysis'. The 'Rule ID' is '1', and there is a 'Valid' checkbox. The 'Rule Name' is 'Rule1', with a 'Rule Clear' button. The 'Event Set' is 'Object Abandone'. The 'Alarm Color' is 'Red' and the 'No Alarm Color' is 'Green'. The 'Alarm Time(s)' slider is set to 5, and the 'Sensitivity' slider is set to 85. There are three checked checkboxes: 'Show Alarm Count', 'Show Alarm Rule', and 'Display Target'. At the bottom are 'Save' and 'Next' buttons.

(3)Event Set ---Missing Object Detecting

1. Select the rule number, and name the rule name; select to enable the rule.
2. Draw the item left over area and click <Start to draw> button to draw the area.
3. Set the alarm time: it means that when the time of the target under the lost state reaches the alarm time, it will trigger the alarm.
4. Set the sensitivity: the greater the value, the higher the sensitivity will be.
5. Set whether to display the alarm statistics, alarm rules and the target or not.
6. After clicking the save button, click the next step, and it will link to the alarm setting interface.

The screenshot shows a configuration window for a rule named 'Rule1'. The 'Arithmetic' dropdown is set to 'Behavior Analysis'. The 'Rule ID' is '1', and there is a 'Valid' checkbox. The 'Rule Name' is 'Rule1', with a 'Rule Clear' button. The 'Event Set' is 'Missing Object Detection'. The 'Alarm Color' is 'Red' and the 'No Alarm Color' is 'Green'. The 'Alarm Time(s)' slider is set to 5, and the 'Sensitivity' slider is set to 85. There are three unchecked checkboxes: 'Show Alarm Count', 'Show Alarm Rule', and 'Display Target'. At the bottom are 'Save' and 'Next' buttons.

(4)Event Set ---Loiter

1. Select the rule number, and name the rule name; select to enable the rule.
2. Draw the wandering area and click <Start to draw> button to draw the area.
3. Set the alarm time: it means that when the time of the target under the wandering state reaches the alarm time, it will trigger the alarm.
4. Set the sensitivity: the greater the value, the higher the sensitivity will be.
5. Set the minimum area: it means that when the movement area of the target (percentage of the area) in the detection area reaches the minimum area, it will trigger the alarm.

The screenshot shows a configuration window for a rule named 'Rule1'. The 'Arithmetic' dropdown is set to 'Behavior Analysis'. The 'Rule ID' is '1', and there is a 'Valid' checkbox. The 'Rule Name' is 'Rule1', with a 'Rule Clear' button. The 'Event Set' is 'Loiter'. The 'Alarm Color' is 'Red' and the 'No Alarm Color' is 'Green'. The 'Alarm Time(s)' slider is set to 10, the 'Sensitivity' slider is set to 40, and the 'Min Area' slider is set to 3%. There are three unchecked checkboxes: 'Show Alarm Count', 'Show Alarm Rule', and 'Display Target'. At the bottom are 'Save' and 'Next' buttons.

- Set whether to display the alarm statistics, alarm rules and the target or not.
- After clicking the save button, click the next step, and it will link to the alarm setting interface.

(5)Event Set ---Running

- Select the rule number, and name the rule name; select to enable the rule.
- Draw the running area and click <Start to draw> button to draw the area.
- Set the minimum moving distance per second: it means that when the moving speed (percentage per second) is great than the minimum moving distance, it enters the running mode.
- Set the sensitivity: the greater the value, the higher the sensitivity will be.
- Set the targets that trigger the alarm, and they can be set as <All>, <Vehicle>, and <People> respectively. <All> means all moving objects.
- Set whether to display the alarm statistics, alarm rules and the target or not.
- After clicking the save button, click the next step, and it will link to the alarm setting interface.

(6)Event Set---Parking

Draw the Parking area and click <Start to draw> button to draw the area.

<Alarm Time(s)> time to activate alarm.

<Sensitivity> bigger value, higher sensitivity

<Speed Threshold> The arlarm will be triggered once the target is out of the range of motion

<Show Alarm Count> show total alarm times.

<Show Alarm Rule> show the defined area on screen.

<Display Target>checked to show target frame

<Save> save to enable.

(7)Event Set---Early Warning

- Select the rule number, and name the rule name; select to enable the rule.
- Draw the Early Warning area and click <Start to draw> button to draw the area.
- Set the sensitivity: the greater the value, the higher the sensitivity will be.
- <Stay time> Dome will give alarm when the object stays in detection area for a certain time you set here.
- Set whether to display the alarm statistics, alarm rules and the target or not.
- After clicking the save button, click the next step, and it will link to the alarm setting interface.

6.3.2.2 Face Detection

This function will enable speed dome to recognize people's face and snapshot and save face picture automatically.

- (1) Check **<Face Detection>**
- (2) Click **<save scene>** to start setting
- (3) Draw the face detection area and click **<Start to draw>** button to draw the area.
- (4) **<Max Face Size>** **<Min Face Size>** setup target face size percent in target region.
- (5) **<Sensitivity>** Set the sensitivity: the higher the value is, the higher the sensitivity will be; when the detection rate is promoted, the false detection will also increase.
- (6) **<Save>** save to enable. Then click the next step, and it will link to the cruise mode interface.

6.3.2.3 Demographics

This function will enable speed dome to count the number of how many people cross the defined line on screen.

- (1) Check **<Demographics>**
- (2) **<Arithmetic>** choose **<People Counting>**
- (3) Draw the Demographics area and click **<Start to draw>** button to draw the area.
- (4) **<Max Target Size>** **<Min Target Size>** setup target people size percent in target region.
- (5) **<Sensitivity>** the higher the value is, the higher the sensitivity will be; when the detection rate is promoted, the false detection will also increase.
- (6) **<Save>** save to enable. Then click the next step, and it will link to the cruise mode interface.

6.3.2.4 Crowd Detection

- (1) Check **< Crowd Detection>**
- (2) Click **<save scene>** to start setting
- (3) Draw the Crowd Detection area and click **<Start to draw>** button to draw the area.
- (4) **<Alarm Time>** Reach the time will trigger the

alarm

(5) **<Sensitivity>** the higher the value is, the higher the sensitivity will be; when the detection rate is promoted, the false detection will also increase.

(6) **<Save>** save to enable. Then click the next step, and it will link to the cruise mode interface.

6.3.2.5 On Duty Detection

(1) Check **< On Duty Detection >**

(2) Click **<save scene>** to start setting

(3) **< On Duty Number >** Set duty number, support 1 and 2 people

(4) Draw the on-duty detection area and click **<Start to draw>** button to draw the area.

(5) **<Absences Alarm Time >** Detect target leaving reach the absent time will trigger the alarm

(6) **<Sensitivity >** Set sensitivity, the bigger value the more sensitive. It improve detection rate also increase the false detection.

(7) **<Max Distance >** **<Min Distance >** Set the maximum and the minimum target size, show the target size in the whole picture.

(8) **<Show Alarm Count >** show total alarm times.

(9) **<Show Alarm Rule >** show the defined area on screen.

(10) **<Display Target >** checked to show target frame

(11) **<Save >** save to enable. Then click the next step, and it will link to the cruise mode interface.

The screenshot shows the configuration interface for 'On Duty Detection'. At the top, there are checkboxes for 'Enable Arithmetic' with options: Behavior Analysis, Face Detection, Demographics, Crowd Detection, On Duty Detection (checked), Video Detection, Audio Detection, and Panorama Tracking. Below this is a 'Save Scene' button. The main configuration area includes: 'Arithmetic' set to 'On Duty Detection'; 'Alarm Color' set to 'Red'; 'No Alarm Color' set to 'Green'; 'On-duty Number' set to '1'; 'Absences Alarm Time' set to '120'; 'Sensitivity' slider set to 2; 'Max Distance' slider set to 15%; 'Min Distance' slider set to 10%; and checkboxes for 'Show Alarm Count', 'Show Alarm Rule', and 'Display Target' (checked). At the bottom are 'Save' and 'Next' buttons.

6.3.2.5 Illegal parking

(1) Check **< Illegal parking >**

(2) Click **<save scene>** to start setting

(3) Draw the illegal parking detection area and click **<Start to draw>** button to draw the area.

(4) Draw the non-stop area in the illegal parking area: one at least and three at most.

(5) Fill in the names of illegal parking area.

(6) Set the no-parking time: it means that when the time of the target in the no-parking area reaches the intrusion timeline, it will trigger the alarm.

(7) Set the sensitivity and it can be set as **<Low>**, **<Medium>** and **<High>**.

(8) **<Save >** save to enable. Then click the next step, and it will link to the cruise mode interface.

The screenshot shows the configuration interface for 'Illegal parking'. At the top, 'VCA' is set to 'Enable'. Below it, 'Scene Number' is '1' and 'Scene Name' is 'Scene 1'. The 'Enable Arithmetic' section includes checkboxes for Behavior Analysis, Face Detection, Demographics, Crowd Detection, On Duty Detection, and Illegal parking (checked). There are also checkboxes for Video Detection, Audio Detection, and Panorama Tracking. A 'Save Scene' button is present. The main configuration area includes: 'Arithmetic' set to 'Illegal parking'; 'No-parking area name' set to 'area 1'; 'No-parking time' set to '1'; and 'Sensitivity' set to 'Low'. At the bottom are 'Save' and 'Next' buttons.

6.3.2.6 Video Detection

- (1) Check < **Video Detection** >
- (2) Click < **save scene** > to start setting
- (3) < **Lens Dignose** > < **Scéen Switch Dignose** >
Check to enable the < lens dignose > and < screen switch dignose >
- (4) < **Sensitivity** > Set the sensitivity , the bigger value the more sensitivity.
- (5) < **Save** > save to enable.

6.3.2.7 Audio Detection

- (1) Check < **Audio Detection** >
- (2) Click < **save scene** > to start setting
- (3) < **Signal Loss Detection** > < **Signal Abnormal Detection** > check to enable these function.
- (4) < **Sensitivity** > Set the sensitivity , the bigger value the more sensitivity.
- (5) < **Save** > save to enable.

6.3.3 VCA Schedule

Setup VCA activation schedule.

- (1) < **VCA Enable** > Indicate the VCA status of the current channel.
- (2) < **Scene Number** > select scene number, range from 1 to 16.
- (3) < **Rule ID** > Connected to the setup VCA rules in < **Event** > When select rule ID, it will bring out setup information of < **VCA Enable** >, < **Rule Name** > and < **Event** >.
- < **Enable** > Enable the setting of < **Schedule** > to setup the day and time of the VCA activation.
- (4) < **Schedule** > Schedule alarms. 4 time periods selectable in a day.
- < **Apply** > enable the setting.
- (5) < **Link Type** >

The alarm output, video recording, snapshot, audio, laser, white light can be selected, and the selected items will come into operation after being checked. In addition to the warning event, the linkage alarms of all behavior analysis don't support the white light.

Description: After the laser is turned on for continuous 300 seconds, the laser will be turned off automatically.

(6)<Save> Save to enable setting.

6.3.4 Cruise Set

Cruise mode used to set the different scenes of VCA cruise.

There are <Time Cruise > and <Schedule Cruise> can be chosen. The up and down button can adjust the cruise order.

<Add>: Add the cruise scene.

<Delete>: Delete the selected cruise scene.

Timed Cruise

Enable the speed dome to switch between different defined VCA functions, time interval range from 30~3600 seconds.

Schedule Cruise

Set valid time period for each defined VCA functions.

<Save> Save the cruise setting.

No.	Scene No.	Scene Name	Retention Time(s)
1	1		30

No.	Scene No.	Scene Name	Start Time	End Time
1	1		00:00	23:59

6.3.5 Advanced

Scene Parameter

<Resume Time> Set the scene resume time-10s, 30s, 60s, 120s, 300s and enable the VCA scene. It shows the PTZ resume time from finishing manual control to return original scene. For example, set the resume time 10s, it means stopping manual PTZ control to 10S, PTZ back to the scene automatically.

Object Set

(1)<Scene Number> Select target Scene No.

(2)<Max Target Size> Set upper limit how much proportion the Object occupy on the screen for recognition

(3)<Min Target Size> Set lower limit

(4)<Target Confirmed Frame> Adjust the target formation rate.

(5)<Enable>

(6)<Save> save to enable.

Advanced

Scene Parameter

Resume Timer(s) 10

Object Set

Scene Number 1

Max Target Size 30%

Min Target Size 3%

Target Confirmed Frame 15

Enable

Save

6.4 OSD

6.4.1 OSD

Camera Title

(1) <Camera Title > Input channel name, then it will show on screen.

(2) <Customize Position> drag < Camera Title > to the target position on screen.

(3) <Color> Choose your favorite color.

Date

(1) <Date> Display date on screen.

(2) <Customize Position> drag <Date> to the target position on screen.

(3) <Color> Choose your favorite color.

(4) <Show Week> Display week on screen

Additional Text

(1) <Additional Text> 5 areas available to put additional text on the screen.

(2) <Customize Position> drag <Date> to the target position on screen.

(3) <Color> Choose your favorite color.

OSD Size

< Self-adaptive> Edit OSD size.

<Save> Save all settings.

< Font Type > < Vector > .<Lattice>



<input checked="" type="checkbox"/> Camera Title	Channel 1
<input type="checkbox"/> Customized Location	Color White
<input checked="" type="checkbox"/> Date	Jan 02 2016
<input type="checkbox"/> Customized Location	Color White
<input type="checkbox"/> Show Week	
<input checked="" type="radio"/> 24 hours	<input type="radio"/> 12 hours
Additional Text	1
<input type="checkbox"/> Customized Location	Color Black
OSD Size	Self-adaptive
Fonts Type	<input checked="" type="radio"/> Vector <input type="radio"/> Lattice
<input type="button" value="Save"/>	

6.4.2 LOGO

Add LOGO picture on screen.

Notes logo picture format must

be .bmp, and must be follow the size.

<LOGO File>, <Browse> to select logo picture, and <Upload>

Notice Device will restart after upload

(1) After restart, select <Enable> to show the logo on screen.

(2) Enable <Customize coordinate Pos> to put the logo on the target position on screen where you click.

LOGO File(*.bmp)	<input type="text"/>	<input type="button" value="Browse"/>	<input type="button" value="Upload"/>
<input type="checkbox"/> Enable			
<input type="checkbox"/> Customize coordinate(click video window)Pos			
Requirements on the image format: 1. The bitmap depth must be 24. 2. The size shall be less than 200*200, and the height and width shall be multiple of 4.			

6.4.3 Privacy Mask

Add up to 24 cover areas on the screen.

- (1) Draw up the area to be sheltered in the small preview window.
- (2) Click <Add area> button.
- (3) Shielding magnification: Set up the magnification value, only when the variable magnification value is greater than the shielding magnification, the private shelter area will display, or it will not display.
- (4) If the user wants to delete the shelter area, click the square frame before the serial number to select corresponding shelter area, then click <Delete area> button to delete the area.

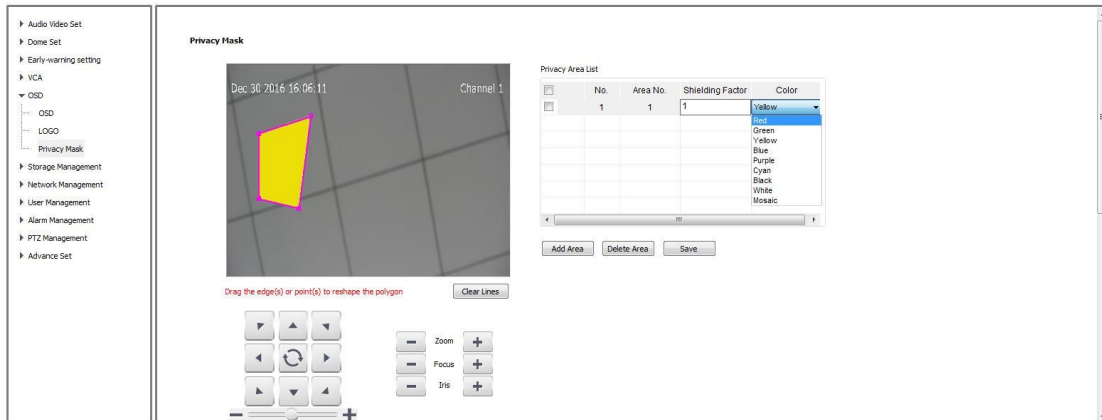

6.5 Storage Management

Notes: The dome camera doesn't support TF card hot plug, and it is recommended to do that after the power cut.e Management

6.5.1 Record Policy

Setup recording schedule.

- (1)<Record Status> Display current record status.
- (2)Select recording type(multiple-choice)
 - <Manual Rec> Check to start recording.
 - <Alarm Rec> Recording will be activated by alarm.
 - <Continous> Timing recording, 4 time periods settable for one day.
- (3)<Offline Video Recording> When it

Record Policy

Record Status: Stopped

Manual Rec
 Alarm Rec
 Continuous

Schedule: Saturday

00:00 ~ 00:00
 00:00 ~ 00:00
 00:00 ~ 00:00
 00:00 ~ 00:00

Copy To: All

Sun Mon Tue Wed Thu Fri Sat

Offline Video Recording: OFF

Notice: Offline recording will follow timing recording rule.

Save

is ON, the device will follow the schedule of <Task Rec> when offline.
(4)<Save> Save.

6.5.2 Pre-Alarm Recording

<Pre-Alarm Recording> record before alarm, or continue to record after alarm.

- (1)<Pre-Alarm Recording> Check to enable.
- (2)< Pre-Alarm Time(5-15)s > Record before alarm.
- (3)< Post-alarmtime(10-60)s > Continues to record after alarm.
- (4)<Save> Save all settings.

Pre-Alarm Recording

Pre-Alarm Recording

Pre-alarm time (5-15)s

Post-alarm time (10-60)s

6.5.3 Storage Set

<Free Disk Space(MB)> Remaining disk space.
 <When HDD is full > Select how to handle the record files when the disk is full.

- <Stop Rec> Stop record new files.
- <Overwrite> Delete the earliest record files.
- < Over write (Exclude Alarm Record Videos)> Delete the earliest record files except event record files.
- <Save>

Storage Set

Storage Policy _____

Free Disk Space(MB) (>=512)MB

When HDD is full

6.5.4 Snapshot Set

- (1) <Timing capture> Enable/Disable timing capture
- (3)<Interval> Set how much interval times between two snapshots.
- (4)<Link FTP>snapshot and upload to FTP server.
- (5)<Link Email>snapshot and send to target email.
- (4)<Save>

Snapshot Set

Image Parameter

Timing Capture

Interval m

Capture Link Link FTP Link Email

6.5.5 Disk Management

<Initialize Disk> format the disk

6.5.6 Net Storage

- (1)<Disk No.> Select disk.
- (2)<Status> Show current disk status information
- (3)<Usage> Shows purpose of disk.

NFS

Disk No.

Status

Usage

IP Address

Mapping Path

(4)<IP Address> Setup IP address of <Network Storage>.

(5)<Mapping Path> Setup disk path of mapping.

(6)<Total Size> Shows used and total capacity of the disk.

(7)<Save>

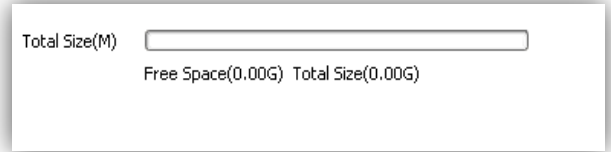

Total Size(M)

Free Space(0.00G) Total Size(0.00G)

6.6 Network Management

6.6.1 IP/TCP Network

<DHCP> check to enable DHCP server will automatically allocate IP address for devices.

<IPv6> Display IPV6 address and subnet mask.

<MTU> Maximum Transmission Unit, range from 500~1500, default value is 1500.

<Ethernet Rate> Select mode and rate of Ethernet card, default mode is <Automatic Detection>, speed unit is MB.

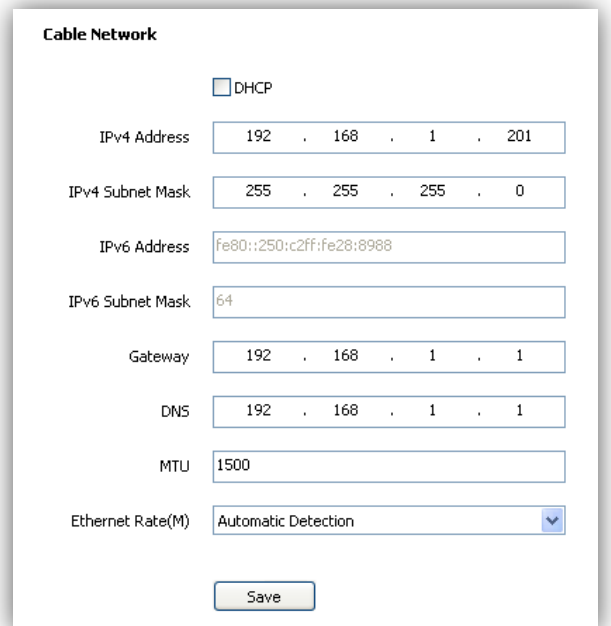

DHCP

IPv4 Address

IPv4 Subnet Mask

IPv6 Address

IPv6 Subnet Mask

Gateway

DNS

MTU

Ethernet Rate(M)

Notes: Devices will restart after change <Ethernet Rate>.

6.6.2 Registration Center

Keep same settings as what you register in DDNS website.

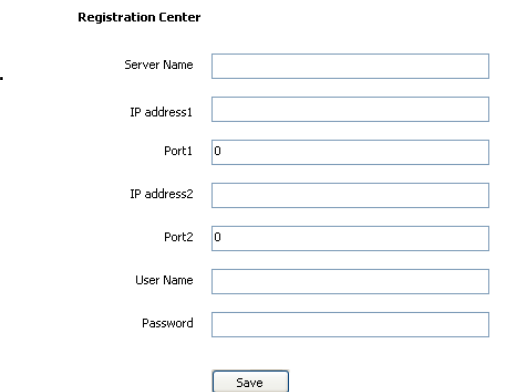

Registration Center

Server Name

IP address1

Port1

IP address2

Port2

User Name

Password

6.6.3 Network Service

DDNS

Keep same settings as what you register in DDNS

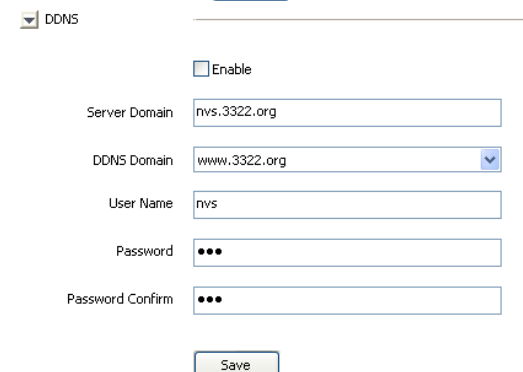

Enable

Server Domain

DDNS Domain

User Name

Password

Password Confirm

website.

FTP

Make sure to insert the memory card.

FTP

Usage Download

Server URL

Port

Path

User Name

Password

PPPoE

Check to enable PPPoE function, enter User name and confirm password.

PPPoE

Enable

User Name

Password

Password Confirm

NTP

<NTP Server> enter server address.

<Port> enter NTP server port.

<Interval> update interval.

NTP

NTP Server

Port

Time Interval(minute)

Others

Set Http and Https port, Enable UPnP and SNMP functions.

Other

UPnP Enable SNMP Enable

HTTP Port

HTTPS Port

RTSP Port

6.6.4 IP Filter

Blacklist

User want to block some IP address, select <Block the Following IPs>, input the block IP address and <Add>, <Save>. Max to add 16 blacklist IP address.

Caution: Please don't add your own IP address in blacklist, otherwise you will not be able to login.

Whitelist

User want to allow only some IP address, select <Allow the Following IP>, input trusted IP address, <Add> and <Save>. Max to 16 whitelist IP address.

Caution: Once enable the whitelist function, please make sure to add your own IP address in whitelist, otherwise you will not be able to login the device.

Cancel blacklist or whitelist

Anytime click <Allow All> and <Save> to cancel all the blacklist and whitelist.

Note: Please restart device after setup blacklist or whitelist.

IP Filter

Forbidden
 Whitelist
 Blacklist

IP	Status

6.7 User management

6.7.1 Add User

<User name> add user, only English letter and figure are available.

<Password> only English letter and figure are available.

<Authority>:

Browse: Can only watch the videos.

browse+ control: Watch video and control PTZ.

browse+ control+ set: Allow all operation except

Add

User Name

Password

Password Confirm

Authority

- Browse
- Browse+Control
- Browse+Control+Set
- Admin

Modify Pwd

User Name

Old Pwd

New Pwd

Password Confirm

user management.

Administrator: All operations available.

6.7.2 Modify password

Select the user you want to modify in the user list, click <Modify Pwd>,input the old password, new password, password confirmation, then click<Modify>.

6.7.3 Delete User

Select targeted user in user list and click **【Delete】** to delete.

6.7.4 Online user

It is selectable to check the login or connection information of the equipment. Select a certain IP and click disconnect to force the IP to log out.

6.8 Alarm Management

6.8.1 Alarm Input

IP Camera alarm input has port1~8, alarm mode include closed circuit alarm and open circuit alarm.

<ON>is closed circuit alarm.

<OFF>is open circuit alarm.

<Alaram Output>/<Link PTZ>/<Link Snap> activate alarm device/ PTZ/Snap.

6.8.2 Alarm Output

Alarm output has port 1~2.

<ON>is closed circuit alarm.

<OFF>is open circuit alarm.

<Delay Time> Set the alarm delay time.

Alarm Input

Input Port: 1 [Enable]

Mode Set: ON

Schedule: Friday

Output Port: 1 [Save]

Mode Set: ON

Delay Time(s): 10

Save

6.8.3 Motion Alarm

(1)<Set Motion Detection Area> Check to draw area on screen.

(2)< Delete Region > Clean drawn area.

Enable

Sensitivity: 76

Schedule: Saturday

Copy To: All, Sun, Mon, Tue, Wed, Thu, Fri, Sat [Apply]

Link Type: Alarm Output

Output Port: All, 1, 2

Save

(3)< Sensitivity> set detection sensitivity, range from 0-100, 0 means the highest sensitivity.

(4)<Schedule> setup alarm arm schedule.

(5)< Alarm Output> set alarm activation.

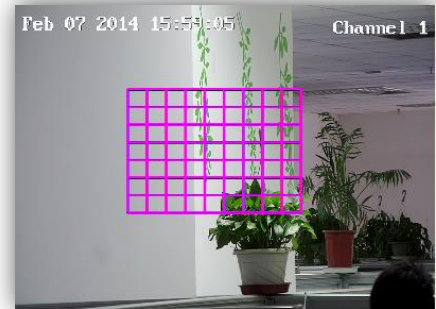

6.8.4 Mask Alarm

Alarm when camera lens is covered.

Enable

Sensitivity

Schedule

<input checked="" type="checkbox"/>	00:00	~	23:59
<input type="checkbox"/>	00:00	~	00:00
<input type="checkbox"/>	00:00	~	00:00
<input type="checkbox"/>	00:00	~	00:00

Copy To All

Sun Mon Tue Wed Thu Fri Sat

Link Type

Link Channel

Link PTZ Type

Number

6.8.5 Email Alarm

(1)<Email Alarm Enable> check to enable sending email after alarm.

(2)Set sending email information:

<SMTP server> <SMTP port><Email Account><Email Password>

(3)<Email Mode>

(4)Input receive email address, support up to 4 email address.

Email Alarm Enable

Email Server

Email Port

Email Account

Email Password

Email Mode

Encryption

Email Subject

Main Email Address

Email Address 1

Email Address 2

Email Address 3

6.8.6 Alarm Server

Set alarm server's IP address and port number,

Alarm Server

Alarm Server

Port

6.9 PTZ Management

PTZ management mode: <Serial Port Set> and <Protocol Set>

<Serial Port Set>:

<Port Name>, <Baud Rate>, <Parity>, <Byte Size>, <Work Mode>

<Protocol Set>:

<Channel>, <Port Name>, <Protocol>, <Address>

Serial Port Set

Port Name	Com2
Baud Rate	9600
Parity Bit	None
Byte Size	8
Stop Bit	1
Work Mode	Transparent Channel

Protocol Set

Channel	1
Port Name	Com2
Protocol	DOME_PELCO_P
Address	1

Save

6.10 Advance

6.10.1 File Location

(1) <Showing frame-rate and bit-stream information> check to display frame rate and bit stream on video.

(2) Set the save path of record files, snapshot, clips and download files.

(3) <Protocol Type> TCP, UDP or multicast.

(4) IP camera has only one channel, user can choose major stream or minor stream.

Showing frame-rate and bit-stream information

Save record files to	d:\NetVideoBrowser\RecordFiles\	Browse
Save snapshots in live view to	d:\NetVideoBrowser\CapturePics\	Browse
Save snapshots when playback to	d:\NetVideoBrowser\PlaybackPics\	Browse
Save clips to	d:\NetVideoBrowser\PlaybackFiles\	Browse
Save downloaded files to	d:\NetVideoBrowser\DownloadFiles\	Browse
Protocol Type	TCP	

Local Set

Channel No. Channel 1 Major

Feb 07 2014 16:35:05 Channel 1 1



6.10.2 System set

(1) <System Information> Display information of CPU, Memory and FLASH.

(2) <Version Information > Display <SDK Version>, <Kernel Version>, <Web Version> and <Factory ID>.

(3) <Language and Time> Set time zone and time synchronous

(4) <Daylight-Saving Time> Enable / Disable Daylight-Saving Time

The screenshot shows a web interface with the following sections:

- System Information:** CPU 05%, Memory 42%, FLASH 65%. A "Refresh" button is present.
- Version Information:** Factory ID: ID0000801940400161030433, Kernel Version: NVSS_V8.1.4.20151230, SDK Version: 4.0.0.3, Web Version: 5.55.15.1216, Access Module: onvif_v2.5.0_20151228.
- Language and Time...:** Region: GMT+08:00, Time: 2016- 1- 2, 13:37:30, Synchronize button.
- Daylight-Saving Time:** Enable checkbox, Start Time: Jan, First, Sun, 00 o'clock, End Time: Jan, First, Sun, 00 o'clock, DST Bias: 120min.

6.10.3 System Maintenance

(1) <Device Control>

Users can carry out < Basic Recovery>, < Complete Recovery >, <Reboot>, < Lens Reset >, < Open / Close remote service > operations.

(2) <Firmware Upgrade> upgrade new firmware. (firmware format: .box/.bin) Upgrade process normally needs a few minutes until indication for completion.

(3) < Open remote service>: Caution: Remote service is design for manufacturer debugging, it may cause risk on device if this function is on.

(4) <Configuration In/Out> Export the alarm/VCA/system setting parameters, import selected files. It will automatically restart after successfully import.

(5) <Auto maintenance>: Set the automatic reboot time of the dome camera to conduct automatic maintenance.

Caution: Please strictly follow the instruction by technical specialist for firmware upgrade.

The screenshot shows a web interface with the following sections:

- System Maintenance:** Device Control buttons: Basic Recovery, Complet...covery, Reboot, Lens Reset, Open re...service.
- Configuration In/Out:** Import (*..box) with Browse and Import buttons, Export with Export button.
- Firmware Upgrade:** Upgrade File (*..bin)or(*..box) with Browse and Upgrade buttons.
- Auto Maintenance:** Restart Time: Never, Save button.

6.10.4 Access Platform

PU Set

User can set the IP address and port number of <Register Server>, <Heartbeat Server>, <Alarm Server> and VSP's port number and VAP's port number. <Channel No. >support <Auto Filling Setting>function.

Register Server: 192 . 168 . 1 . 100
 Port: 10102
 Heartbeat Server: 192 . 168 . 1 . 100
 Port: 10102
 Alarm Server: 192 . 168 . 1 . 100
 Port: 2122
 Device ID:
 Device Name:
 VSP Port: 8000
 VAP Port: 9000

SIP Set

PU set support 【SIP】 protocol setting.

SIP Set
 Server IP: 0 . 0 . 0 . 0
 Server Port: 0
 Server ID:
 Device ID:
 User Name:
 Password:
 RegValidity: 0
 Keep-alive: 0
 Heartbeat Interval: 0
 Heart Rate: 0
 Need to Register

Platform Enabled

<Platform enabled>: Select the platform, check onvif, 28181, rtsp, CGI, P2P services supported by the platform (services supported are different for specific models), and users can set whether to activate it on sole discretion or not.

Platform Enabled
 Platform List: trade
 p2p onvif rtsp cgi
 Save

Chapter 7 Simple Problem-solving Methods

symptom	Possible causes	Solutions
Power on no action,	Power supply is damaged or not enough power	Replace the power supply

No images,	Power cable fault	Corrected
Machine is not self checking	Line problems	Troubleshoot line, measure IP speed dome's voltage
Self action properly, but can't ping	Network line or switch damaged	Test by IP speed dome connect to PC directly
	IP speed dome's IP address and PC's IP address aren't in same network segment	Change IP address to insure they are in the same network segment and aren't conflict.
Ping is working normally, but can't login	User name or password error	Check user name or password
	Port number error	Check port number
	Login account more than limit	Disconnect other client host
No video after login	Login account more than limit	Connect video by proxy server
	Camera is damaged	Check log record
	Parameter setting error	Restore the default parameters
Image is not stable	IP address conflict; MAC address conflict; broadcast storm	Check network setting
	Network line problem	Check network line
Image is not stable, delay,	PC performance isn't enough	Check CPU utilization, reduce code stream or resolution
	Frame rate is low	Change frame rate in more than 20
	The network bandwidth shortage	Replace the gigabit switches
	Decoder's performance isn't enough	Change decoder
IP Speed dome can't be controlled	Serial port Settings error	Check and change serial port number to "COM2"
	Protocol, Baud rate, address error	Check IP speed dome's protocol, baud rate and address
IP Speed dome restart again and	Power supply isn't enough, voltage isn't stable	Measure IP speed dome's voltage to insure stability

again	PPPOE dialing failed	Check and change dialing parameter
	Camera is damaged	Replace the camera
	Parameter setting error	Restore the default parameters

Chapter 8 After-sales Service

The HD Network IR speed dome products, the company offers one-year warranty. Product warranty, the company provides a free service, but if any of the following circumstances, is charged fee for material costs work:

- Do not operate in accordance with the provisions of the manual
- The speed dome damage caused by a case of the lightning strikes, fires and irresistible natural disasters;
- Matching problems arising from poor design to other manufacturers products cause damage;

Company statement

- As we continue to introduce new technologies and product specifications are subject to change without prior notice.

Appendix I Lightning and Surge

Outdoor Dome Camera need to consider lightening, anti-surge, on the premise of ensuring electrical safety, may take the following measures:

- Signal transmission lines and high voltage equipment or high voltage cables must be at least 50 meters distance between;
- Try to choose outdoor wiring along the eaves line;
- For open field must be sealed steel tubes buried cabling, grounding and steel pipe, the absolute prohibition of the use of overhead wiring;
- In areas of severe thunderstorm or high-voltage area (such as high-voltage substations), lightning protection equipment, as well as for additional installed power must be taken measures such as installing lightning rods
- Outdoor lightning protection and grounding design of devices and circuits must be combined with building mine requires unified consideration and in accordance with the requirements of the relevant national standards, industry standards;
- System must be equipotential earthing. Earthing system anti-interference must be met and the dual requirements of electrical safety, and shall not be mixed with strong power network neutral wire shorted or separately when grounding, grounding impedance less than 4 ohms, ground wire cut-area must be not greater than 25mm² lines shorted

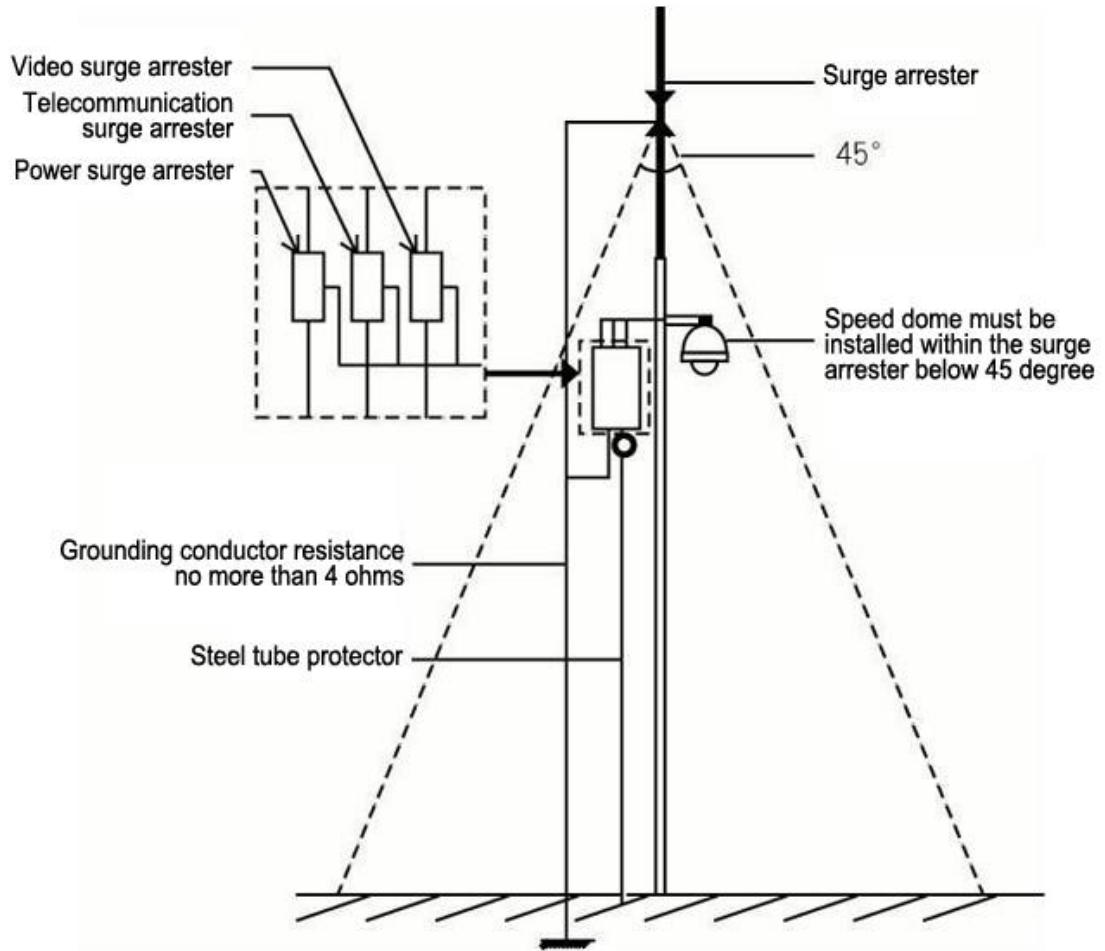

Appendix II::Hoisting construction Guide

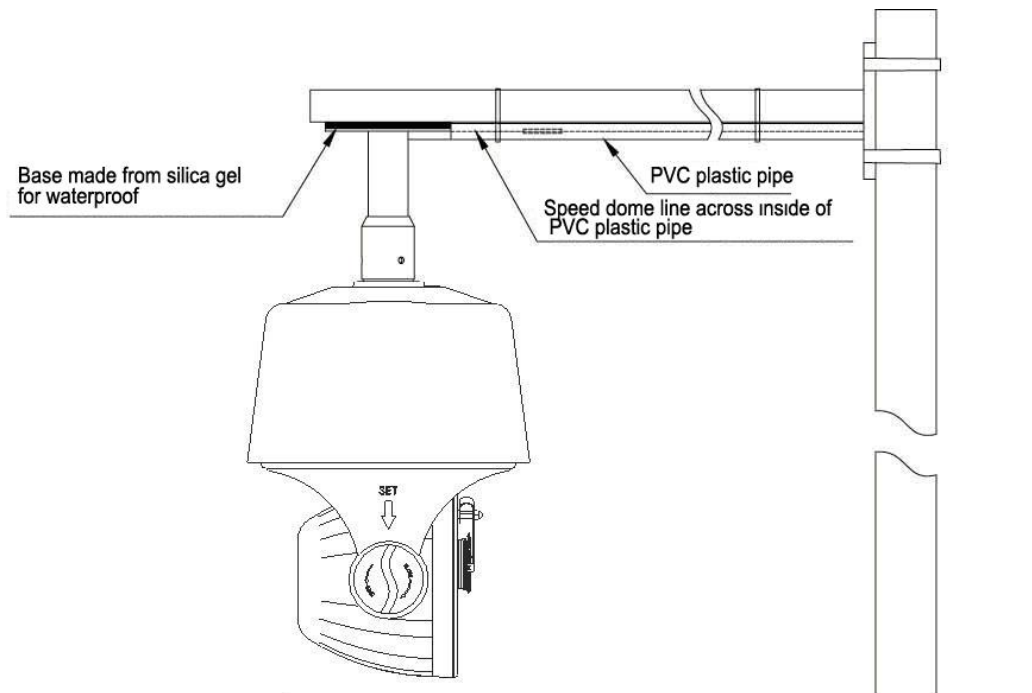

Pendent mount bracket outdoor waterproof construction scheme I

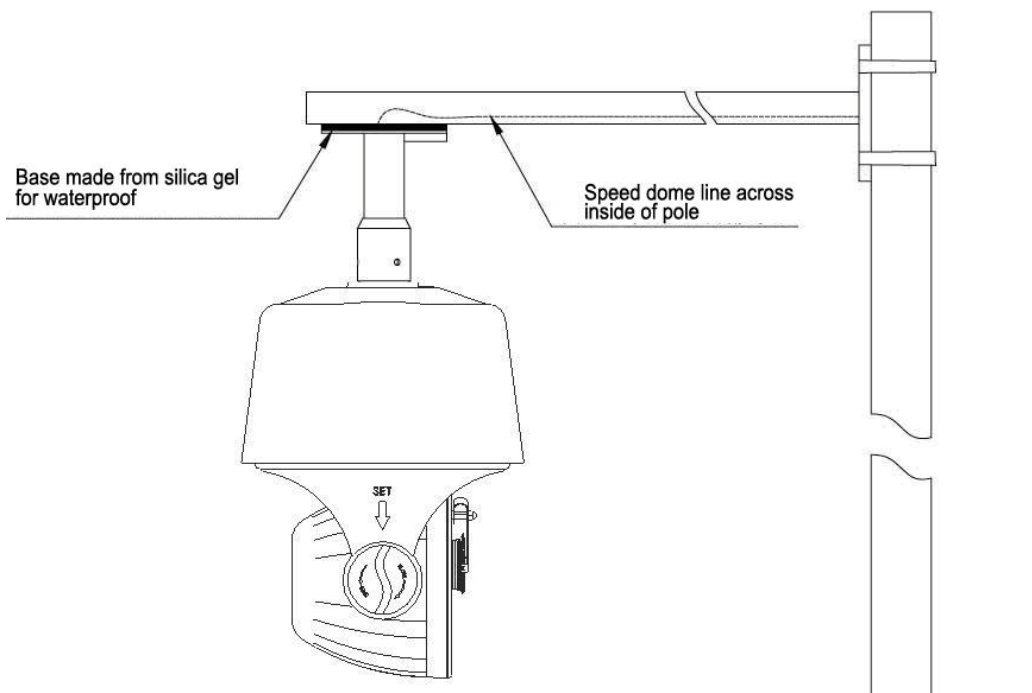

Pendent mount bracket outdoor waterproof construction scheme II

